



Grass Valley
WE LOVE LIVE

MV-1216 / MV-1232
STANDALONE MULTIVIEWERS
1 RU High Performance Multiviewer Systems

Installation and Operation Manual

13-06511-000 AA
2024-01-30

www.grassvalley.com

FCC Compliance

In order to comply with FCC/CFR47: Part 15 regulations, it is necessary to use high-quality, triple-screened Media or Monitor cable assemblies with integrated ferrite suppression at both ends.

Patent Information

This product may be protected by one or more patents.

For further information, please visit: www.grassvalley.com/patents/

Copyright and Trademark Notice

Grass Valley®, GV® and the Grass Valley logo and/or any of the Grass Valley products listed in this document are trademarks or registered trademarks of GVBB Holdings SARL, Grass Valley USA, LLC, or one of its affiliates or subsidiaries. All other intellectual property rights are owned by GVBB Holdings SARL, Grass Valley USA, LLC, or one of its affiliates or subsidiaries. All third party intellectual property rights (including logos or icons) remain the property of their respective owners.

Copyright © 2022 GVBB Holdings SARL and Grass Valley USA, LLC. All rights reserved.

Specifications are subject to change without notice.

Terms and Conditions

Please read the following terms and conditions carefully. By using MV-1216 / MV-1232 Standalone Multiviewers documentation, you agree to the following terms and conditions.

Grass Valley hereby grants permission and license to owners of Sirius Compact to use their product manuals for their own internal business use. Manuals for Grass Valley products may not be reproduced or transmitted in any form or by any means, electronic or mechanical, including photocopying and recording, for any purpose unless specifically authorized in writing by Grass Valley.

A Grass Valley manual may have been revised to reflect changes made to the product during its manufacturing life. Thus, different versions of a manual may exist for any given product. Care should be taken to ensure that one obtains the proper manual version for a specific product serial number.

Information in this document is subject to change without notice and does not represent a commitment on the part of Grass Valley.

Warranty information is available from the Legal Terms and Conditions section of Grass Valley's website (www.grassvalley.com).

Title	MV-1216 / MV-1232 Standalone Multiviewers Installation and Operation Manual
Part Number	13-06511-000 AA
Revision	2024-01-30, 20:11

Important Safety Information

This section provides important safety guidelines for operators and service personnel. Specific warnings and cautions appear throughout the manual where they apply. Please read and follow this important information, especially those instructions related to the risk of electric shock or injury to persons.

Symbols and Their Meanings



Indicates that dangerous high voltage is present within the equipment enclosure that may be of sufficient magnitude to constitute a risk of electric shock.



Indicates that the user, operator or service technician should refer to the product manuals for important operating, maintenance, or service instructions.



This is a prompt to note the fuse rating when replacing fuses. The fuse referenced in the text must be replaced with one having the ratings indicated.



Identifies a protective grounding terminal which must be connected to earth ground prior to making any other equipment connections.



Identifies an external protective grounding terminal which may be connected to earth ground as a supplement to an internal grounding terminal.



Indicates that static sensitive components are present, which may be damaged by electrostatic discharge. Use anti-static procedures, equipment and surfaces during servicing.



Indicates that the equipment has more than one power supply cord, and that all power supply cords must be disconnected before servicing to avoid electric shock.



The presence of this symbol in or on Grass Valley equipment means that it has been tested and certified as complying with applicable Underwriters Laboratory (UL) regulations and recommendations for USA.



The presence of this symbol in or on Grass Valley equipment means that it has been tested and certified as complying with applicable Canadian Standard Association (CSA) regulations and recommendations for USA/Canada.



The presence of this symbol in or on Grass Valley equipment means that it has been tested and certified as complying with applicable Underwriters Laboratory (UL) regulations and recommendations for USA/Canada.



The presence of this symbol in or on Grass Valley equipment means that it has been tested and certified as complying with applicable Intertek Testing Services regulations and recommendations for USA/Canada.



The presence of this symbol in or on Grass Valley product means that it complies with all applicable European Union (CE) directives.



The presence of this symbol in or on Grass Valley product means that it complies with safety of laser product applicable standards.

Warnings



A warning indicates a possible hazard to personnel, which may cause injury or death. Observe the following general warnings when using or working on this equipment:

- Appropriately listed/certified mains supply power cords must be used for the connection of the equipment to the rated mains voltage.
- This product relies on the building's installation for short-circuit (over-current) protection. Ensure that a fuse or circuit breaker for the rated mains voltage is used on the phase conductors.
- Any instructions in this manual that require opening the equipment cover or enclosure are for use by qualified service personnel only.
- Do not operate the equipment in wet or damp conditions.
- This equipment is grounded through the grounding conductor of the power cords. To avoid electrical shock, plug the power cords into a properly wired receptacle before connecting the equipment inputs or outputs.
- Route power cords and other cables so they are not likely to be damaged. Properly support heavy cable bundles to avoid connector damage.
- Disconnect power before cleaning the equipment. Do not use liquid or aerosol cleaners; use only a damp cloth.
- Dangerous voltages may exist at several points in this equipment. To avoid injury, do not touch exposed connections and components while power is on.
- High leakage current may be present. Earth connection of product is essential before connecting power.
- Prior to servicing, remove jewelry such as rings, watches, and other metallic objects.
- To avoid fire hazard, use only the fuse type and rating specified in the service instructions for this product, or on the equipment.
- To avoid explosion, do not operate this equipment in an explosive atmosphere.
- Use proper lift points. Do not use door latches to lift or move equipment.
- Avoid mechanical hazards. Allow all rotating devices to come to a stop before servicing.
- Have qualified service personnel perform safety checks after any service.

Cautions



A caution indicates a possible hazard to equipment that could result in equipment damage. Observe the following cautions when operating or working on this equipment:

- This equipment is meant to be installed in a restricted access location.
- When installing this equipment, do not attach the power cord to building surfaces.
- Products that have no on/off switch, and use an external power supply must be installed in proximity to a main power outlet that is easily accessible.
- Use the correct voltage setting. If this product lacks auto-ranging power supplies, before applying power ensure that each power supply is set to match the power source.
- Provide proper ventilation. To prevent product overheating, provide equipment ventilation in accordance with the installation instructions.
- Do not operate with suspected equipment failure. If you suspect product damage or equipment failure, have the equipment inspected by qualified service personnel.
- To reduce the risk of electric shock, do not perform any servicing other than that contained in the operating instructions unless you are qualified to do so. Refer all servicing to qualified service personnel.
- This unit may have more than one power supply cord. Disconnect all power supply cords before servicing to avoid electric shock.
- Follow static precautions at all times when handling this equipment. Servicing should be done in a static-free environment.
- To reduce the risk of electric shock, plug each power supply cord into separate branch circuits employing separate service grounds.

Electrostatic Discharge (ESD) Protection



Electrostatic discharge occurs when electronic components are improperly handled and can result in intermittent failure or complete damage adversely affecting an electrical circuit. When you remove and replace any card from a frame always follow ESD-prevention procedures:

- Ensure that the frame is electrically connected to earth ground through the power cord or any other means if available.
- Wear an ESD wrist strap ensuring that it makes good skin contact. Connect the grounding clip to an *unpainted surface* of the chassis frame to safely ground unwanted ESD voltages. If no wrist strap is available, ground yourself by touching the *unpainted* metal part of the chassis.
- For safety, periodically check the resistance value of the antistatic strap, which should be between 1 and 10 megohms.
- When temporarily storing a card make sure it is placed in an ESD bag.
- Cards in an earth grounded metal frame or casing do not require any special ESD protection.

Battery Handling



This product may include a backup battery. There is a danger of explosion if the battery is replaced incorrectly. Replace the battery only with the same or equivalent type recommended by the manufacturer. To dispose of used batteries and/or your Grass Valley equipment, please consult your local goods disposal and recycling program.

Cautions for LCD and TFT Displays



Excessive usage may harm your vision. Rest for 10 minutes for every 30 minutes of usage.

If the LCD or TFT glass is broken, handle glass fragments with care when disposing of them. If any fluid leaks out of a damaged glass cell, be careful not to get the liquid crystal fluid in your mouth or skin. If the liquid crystal touches your skin or clothes, wash it off immediately using soap and water. Never swallow the fluid. The toxicity is extremely low but caution should be exercised at all times.

Mesures de sécurité et avis importants

La présente section fournit des consignes de sécurité importantes pour les opérateurs et le personnel de service. Des avertissements ou mises en garde spécifiques figurent dans le manuel, dans les sections où ils s'appliquent. Prenez le temps de bien lire les consignes et assurez-vous de les respecter, en particulier celles qui sont destinées à prévenir les décharges électriques ou les blessures.

Signification des symboles utilisés



Signale la présence d'une tension élevée et dangereuse dans le boîtier de l'équipement ; cette tension peut être suffisante pour constituer un risque de décharge électrique.



Avertit l'utilisateur, l'opérateur ou le technicien de maintenance que des instructions importantes relatives à l'utilisation et à l'entretien se trouvent dans la documentation accompagnant l'équipement.



Invite l'utilisateur, l'opérateur ou le technicien de maintenance à prendre note du calibre du fusible lors du remplacement de ce dernier. Le fusible auquel il est fait référence dans le texte doit être remplacé par un fusible du même calibre.



Identifie une borne de mise à la terre de protection. Il faut relier cette borne à la terre avant d'effectuer toute autre connexion à l'équipement.



Identifie une borne de mise à la terre externe qui peut être connectée en tant que borne de mise à la terre supplémentaire.



Signale la présence de composants sensibles à l'électricité statique et qui sont susceptibles d'être endommagés par une décharge électrostatique. Utilisez des procédures, des équipements et des surfaces antistatiques durant les interventions d'entretien.



Le symbole ci-contre signifie que l'appareil comporte plus d'un cordon d'alimentation et qu'il faut débrancher tous les cordons d'alimentation avant toute opération d'entretien, afin de prévenir les chocs électriques.



La marque UL certifie que l'appareil visé a été testé par Underwriters Laboratory (UL) et reconnu conforme aux exigences applicables en matière de sécurité électrique en vigueur au Canada et aux États-Unis.



La marque C-CSA-US certifie que l'appareil visé a été testé par l'Association canadienne de normalisation (CSA) et reconnu conforme aux exigences applicables en matière de sécurité électrique en vigueur au Canada et aux États-Unis.



La marque C-UL-US certifie que l'appareil visé a été testé par Underwriters Laboratory (UL) et reconnu conforme aux exigences applicables en matière de sécurité électrique en vigueur au Canada et aux États-Unis.



La marque ETL Listed d'Intertek pour le marché Nord-Américain certifie que l'appareil visé a été testé par Intertek et reconnu conforme aux exigences applicables en matière de sécurité électrique en vigueur au Canada et aux États-Unis.



Le marquage CE indique que l'appareil visé est conforme aux exigences essentielles des directives applicables de l'Union européenne en matière de sécurité électrique, de compatibilité électromagnétique et de conformité environnementale.



Le symbole ci-contre sur un appareil Grass Valley ou à l'intérieur de l'appareil indique qu'il est conforme aux normes applicables en matière de sécurité laser.

Avertissements



Les avertissements signalent des conditions ou des pratiques susceptibles d'occasionner des blessures graves, voire fatales. Veuillez vous familiariser avec les avertissements d'ordre général ci-dessous :

- Un cordon d'alimentation dûment homologué doit être utilisé pour connecter l'appareil à une tension de secteur de 120 V CA ou 240 V CA.
- La protection de ce produit contre les courts-circuits (surintensités) dépend de l'installation électrique du bâtiment. Assurez-vous qu'un fusible ou un disjoncteur pour 120 V CA ou 240 V CA est utilisé sur les conducteurs de phase.
- Dans le présent manuel, toutes les instructions qui nécessitent d'ouvrir le couvercle de l'équipement sont destinées exclusivement au personnel technique qualifié.
- N'utilisez pas cet appareil dans un environnement humide.

- Cet équipement est mis à la terre par le conducteur de mise à la terre des cordons d'alimentation. Pour éviter les chocs électriques, branchez les cordons d'alimentation sur une prise correctement câblée avant de brancher les entrées et sorties de l'équipement.
- Acheminez les cordons d'alimentation et autres câbles de façon à ce qu'ils ne risquent pas d'être endommagés. Supportez correctement les enroulements de câbles afin de ne pas endommager les connecteurs.
- Coupez l'alimentation avant de nettoyer l'équipement. Ne pas utiliser de nettoyeurs liquides ou en aérosol. Utilisez uniquement un chiffon humide.
- Des tensions dangereuses peuvent exister en plusieurs points dans cet équipement. Pour éviter toute blessure, ne touchez pas aux connexions ou aux composants exposés lorsque l'appareil est sous tension.
- Avant de procéder à toute opération d'entretien ou de dépannage, enlevez tous vos bijoux (notamment vos bagues, votre montre et autres objets métalliques).
- Pour éviter tout risque d'incendie, utilisez uniquement les fusibles du type et du calibre indiqués sur l'équipement ou dans la documentation qui l'accompagne.
- Ne pas utiliser cet appareil dans une atmosphère explosive.
- Présence possible de courants de fuite. Un raccordement à la masse est indispensable avant la mise sous tension.
- Après tout travail d'entretien ou de réparation, faites effectuer des contrôles de sécurité par le personnel technique qualifié.

Mises en garde



Les mises en garde signalent des conditions ou des pratiques susceptibles d'endommager l'équipement. Veuillez vous familiariser avec les mises en garde ci-dessous :

- L'appareil est conçu pour être installé dans un endroit à accès restreint.
- Au moment d'installer l'équipement, ne fixez pas les cordons d'alimentation aux surfaces intérieures de l'édifice.
- Les produits qui n'ont pas d'interrupteur marche-arrêt et qui disposent d'une source d'alimentation externe doivent être installés à proximité d'une prise de courant facile d'accès.
- Si l'équipement n'est pas pourvu d'un modules d'alimentation auto-adaptables, vérifiez la configuration de chacun des modules d'alimentation avant de les mettre sous tension.
- Assurez une ventilation adéquate. Pour éviter toute surchauffe du produit, assurez une ventilation de l'équipement conformément aux instructions d'installation.
- N'utilisez pas l'équipement si vous suspectez un dysfonctionnement du produit. Faites-le inspecter par un technicien qualifié.
- Pour réduire le risque de choc électrique, n'effectuez pas de réparations autres que celles qui sont décrites dans le présent manuel, sauf si vous êtes qualifié pour le faire. Confiez les réparations à un technicien qualifié. La maintenance doit se réaliser dans un milieu libre d'électricité statique.

- L'appareil peut comporter plus d'un cordon d'alimentation. Afin de prévenir les chocs électriques, débrancher tous les cordons d'alimentation avant toute opération d'entretien.
- Veillez à toujours prendre les mesures de protection antistatique appropriées quand vous manipulez l'équipement.
- Pour réduire le risque de choc électrique, branchez chaque cordon d'alimentation dans des circuits de dérivation distincts utilisant des zones de service distinctes.

Protection contre les décharges électrostatiques (DES)



Une décharge électrostatique peut se produire lorsque des composants électroniques ne sont pas manipulés de manière adéquate, ce qui peut entraîner des défaillances intermittentes ou endommager irrémédiablement un circuit électrique. Au moment de remplacer une carte dans un châssis, prenez toujours les mesures de protection antistatique appropriées :

- Assurez-vous que le châssis est relié électriquement à la terre par le cordon d'alimentation ou tout autre moyen disponible.
- Portez un bracelet antistatique et assurez-vous qu'il est bien en contact avec la peau. Connectez la pince de masse à une *surface non peinte* du châssis pour détourner à la terre toute tension électrostatique indésirable. En l'absence de bracelet antistatique, déchargez l'électricité statique de votre corps en touchant une surface métallique *non peinte* du châssis.
- Pour plus de sécurité, vérifiez périodiquement la valeur de résistance du bracelet antistatique. Elle doit se situer entre 1 et 10 mégohms.
- Si vous devez mettre une carte de côté, assurez-vous de la ranger dans un sac protecteur antistatique.
- Les cartes qui sont reliées à un châssis ou boîtier métallique mis à la terre ne nécessitent pas de protection antistatique spéciale.

Manipulation de la pile



Ce produit peut inclure une pile de sauvegarde. Il y a un risque d'explosion si la pile est remplacée de manière incorrecte. Remplacez la pile uniquement par un modèle identique ou équivalent recommandé par le fabricant. Disposez des piles usagées et de tout équipement Grass Valley conformément aux instructions de votre programme de récupération local pour le recyclage des équipements électroniques.

Précautions pour les écrans LCD et TFT



Regarder l'écran pendant une trop longue période de temps peut nuire à votre vision. Prenez une pause de 10 minutes, après 30 minutes d'utilisation.

Si l'écran LCD ou TFT est brisé, manipulez les fragments de verre avec précaution au moment de vous en débarrasser. veillez à ce que le cristal liquide n'entre pas en contact avec la peau ou la bouche. En cas de contact avec la peau ou les vêtements, laver immédiatement à l'eau savonneuse. Ne jamais ingérer le liquide. La toxicité est extrêmement faible, mais la prudence demeure de mise en tout temps.

Environmental Information

European (CE) WEEE directive.



This symbol on the product(s) means that at the end of life disposal it should not be mixed with general waste.

Visit www.grassvalley.com for recycling information.

Grass Valley believes this environmental information to be correct but cannot guarantee its completeness or accuracy since it is based on data received from sources outside our company. All specifications are subject to change without notice.

If you have questions about Grass Valley environmental and social involvement (WEEE, RoHS, REACH, etc.), please contact us at environment@grassvalley.com.

Lithium Batteries

Battery Warning

CAUTION

This equipment contains a lithium battery.
There is a danger of explosion if this is replaced incorrectly.
Replace only with the same or equivalent type.
Dispose of used batteries according to the manufacturer's instructions.
Batteries **shall only** be replaced by trained service technicians.

Your Grass Valley equipment usually comes with at least one button battery located on the main printed circuit board. The batteries are used for backup and should not need to be replaced during the lifetime of the equipment.

Battery Disposal

Before disposing of your Grass Valley equipment, please remove the battery as follows:

- 1 Make sure the AC adapter / power Cord is unplugged from the power outlet.
- 2 Remove the protective cover from your equipment.
- 3 Gently remove the battery from its holder using a blunt instrument for leverage such as a screwdriver if necessary. In some cases the battery will need to be desoldered from the PCB.

- 4 Dispose of the battery and equipment according to your local environmental laws and guidelines.

WARNING

- Be careful not to short-circuit the battery by adhering to the appropriate safe handling practices.
- Do not dispose of batteries in a fire as they may explode.
- Batteries may explode if damaged or overheated.
- Do not dismantle, open or shred batteries.
- In the event of a battery leak, do not allow battery liquid to come in contact with skin or eyes.
- Seek medical help immediately in case of ingestion, inhalation, skin or eye contact, or suspected exposure to the contents of an opened battery.

Laser Safety - Fiber Output SFP and QSFP Modules Warning

LASER SAFETY



The average optical output power does not exceed 0 dBm (1mW) under normal operating conditions. Unused optical outputs should be covered to prevent direct exposure to the laser beam.

Even though the power of these lasers is low, the beam should be treated with caution and common sense because it is intense and concentrated. Laser radiation can cause irreversible and permanent damage of eyesight. Please read the following guidelines carefully:

- Make sure that a fiber is connected to the board's fiber outputs before power is applied. If a fiber cable (e.g. patchcord) is already connected to an output, make sure that the cable's other end is connected, too, before powering up the board.
- **Do not** look in the end of a fiber to see if light is coming out. The laser wavelengths being used are totally invisible to the human eye and can cause permanent damage. Always use optical instrumentation, such as an optical power meter, to verify light output.

Mains Supply Voltage

Before connecting the equipment, observe the safety warnings section and ensure that the local mains supply is within the rating stated on the rear of the equipment.

Safety and EMC Standards

This equipment complies with the following standards:

Safety Standards



Information Technology Equipment - Safety Part 1

EN60950-1: 2006

Safety of Information Technology Equipment Including Electrical Business Equipment.

UL1419 (4th Edition)

Standard for Safety – Professional Video and Audio equipment (UL file number E193966)

EMC Standards

This unit conforms to the following standards:

EN55032:2015 (Class A)

Electromagnetic Compatibility of multimedia equipment - Emission requirements

EN61000-3-2:2014 (Class A)

Electromagnetic Compatibility - Limits for harmonic current emissions

EN61000-3-3:2013

Electromagnetic Compatibility - Limits of voltage changes, voltage fluctuations and flicker

EN55103-2:2009 (Environment E2)

Electromagnetic Compatibility, Product family standard for audio, video, audio-visual and entertainment lighting control apparatus for professional use. Part 2. Immunity

WARNING

This equipment is compliant with Class A of CISPR 32. In a residential environment this equipment may cause radio interference.

FCC / CFR 47:Part 15 (Class A)

Federal Communications Commission Rules Part 15, Subpart B

Caution to the user that changes or modifications not expressly approved by the party responsible for compliance could void the user's authority to operate the equipment.

Note: This equipment has been tested and found to comply with the limits for a Class A digital device, pursuant to part 15 of the FCC Rules. These limits are designed to provide reasonable protection against harmful interference when the equipment is operated in a commercial environment.

This equipment generates, uses, and can radiate radio frequency energy and, if not installed and used in accordance with the instruction manual, may cause harmful interference to radio communications.

Operation of this equipment in a residential area is likely to cause harmful interference in which case the user will be required to correct the interference at his own expense.

EMC Performance of Cables and Connectors

Grass Valley products are designed to meet or exceed the requirements of the appropriate European EMC standards. In order to achieve this performance in real installations it is essential to use cables and connectors with good EMC characteristics.

All signal connections (including remote control connections) shall be made with screened cables terminated in connectors having a metal shell. The cable screen shall have a large-area contact with the metal shell.

SIGNAL/DATA PORTS

For unconnected signal/data ports on the unit, fit shielding covers. For example, fit EMI blanking covers to SFP+ type ports; and fit 75 Ω RF terminators to BNC type ports.

COAXIAL CABLES

Coaxial cables connections (particularly serial digital video connections) shall be made with high-quality double-screened coaxial cables such as Belden 8281 or BBC type PSF1/2M, Belden 1694A (for 3Gbps), and Belden 4794A (for 12Gbps).

D-TYPE CONNECTORS

D-type connectors shall have metal shells making good RF contact with the cable screen. Connectors having "dimples" which improve the contact between the plug and socket shells, are recommended.

toc

Table of Contents

1 Introduction	17
Overview.....	17
Features.....	17
Options	17
Multiviewer Models	18
Order Codes.....	18
Multiviewer Remote Panels	19
Order Codes.....	19
Remote panel communication with the MV-1200 Series on a network.....	19
2 Operation.....	21
Touch Screen LCD display	21
3 Web Browser User Interface	23
Graphical User Interface	23
Module Menu	24
Boards	24
Screen	25
Video Source Names	25
Audio Meter.....	26
Audio Channel Names.....	27
Audio Monitor Outputs.....	28
GPIs.....	29
GPOs.....	30
Network Settings.....	30
SNMP	31
Siera Router	32
GV Router Network.....	33
MV Connection External Matrix.....	33
Internal Matrix Controller	34
HDR and Colorimetry	34
Setup Selected Video Source	35
Audio Tab	36
.....	36
Alarm	36
Overscan	37
Copy	38
Setup Time.....	39
Update Firmware.....	40
Layout Menu	41
Setup Layout	41

Group Menu	42
Select All/Unselect All	42
Object Menu	43
Edit Object	44
Tile & Transformation Tab	44
Border Tab	45
Source Tab	45
UMD Tab	46
Audio Meter (Layout and Properties) Tab	48
Audio Meter (Position) Tab	50
Error Tab	51
Tally Tab	52
VBI Tab	53
WSS Tab	53
Safe Area Generator Tab	54
Grid Menu	55
Help Menu	55
About	55
Logging	57
Audio	59
Reference	59
Source Data	59
Alarms	59
Environmental	60
GPIO Inputs	60
GPIO Input Signals	60
GPIO Input Circuit	61
GPIO Outputs	62
GPIO Output Signals	62
GPIO Fused Power	63
Dimensions	64
Contact Us	65

1 Introduction

Overview

The MV-1216 and MV-1232 Standalone Multiviewers are fully-featured broadcast-quality multiviewers in 1RU format with up to 3G SDI inputs as standard, with the option for 12G SDI inputs.

Features

- For 2K FHD operation - up to 4 Independent outputs are supported with simultaneous SDI and HDMI outputs at 3G-SDI FHD50/59/60 resolution.
- For 4K UHD operation - up to 2 independent outputs are supported with simultaneous QL-4x3G- SDI and HDMI outputs at UHD50/59/60 resolution.
- 16 or 32 inputs up to 3G-SDI FHD50/59/60 resolution.
- Input SW option to support up to 12G-SDI UHD50/59/60 resolution.
- Sources can be displayed on any output screen with arbitrary size and location.
- Sources may be duplicated in the same location without consuming additional scaler resources.
- Power supplies with IEC inlets are hot-swappable and power sharing. Intelligent power supply modules are continuously logged for status, temperature and efficiency.
- Quiet low-noise fans adapt to frame temperature.
- Remote control over ethernet via an integrated HTML5 browser.
- A long-life colour touch screen LCD displays MV and source status and can be used for local control.

Options

- Second smart-PSU module to support dual-redundancy operation
- MV-1200 Series remote control panel

Multiviewer Models

Order Codes

Model	Description	Inputs
MV-1216	MV-1200 Series 16 Input Multiviewer with 4 Heads	16x3G-SDI
MV-1232	MV-1200 Series 32 Input Multiviewer with 4 Heads	32x3G-SDI
MV-1216-OPT-12G	License to enable 12G SDI inputs for MV-1216	
MV-1232-OPT-12G	License to enable 12G SDI inputs for MV-1232	
MV-1200-PS	MV-1200 Series Standalone Multiviewer power supply	



Fig. 1-1: Front View (All Models)



Fig. 1-2: Rear View (MV-1216)



Fig. 1-3: Rear View (MV-1232)

Multiviewer Remote Panels

Order Codes

Model	Description
MV-1216-RCP	MV-1200 Series Standalone Multiviewer remote control panel with TFT LCD and 18 switches with GPIO breakout
MV-1232-RCP	MV-1200 Series Standalone Multiviewer remote control panel with TFT LCD and 34 switches with GPIO breakout
MV-1200-RCP-PS	MV-1200 Series Standalone Multiviewer remote control panel 12V power supply with IEC 15W

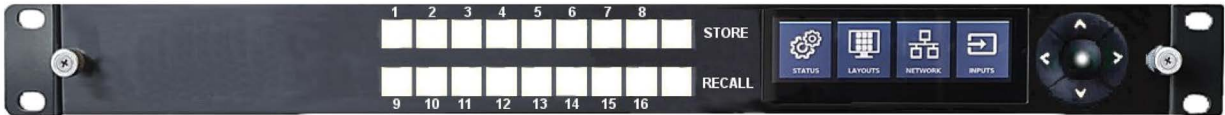

Fig. 1-4: Front View (MV-1216-RCP)

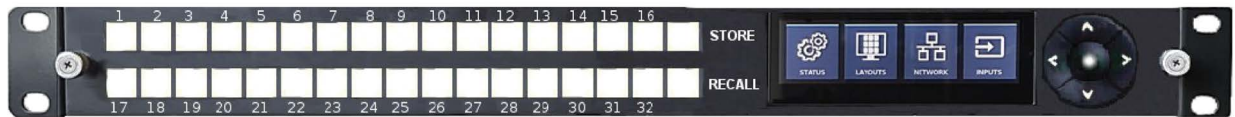

Fig. 1-5: Front View (MV-1232-RCP)

Remote panel communication with the MV-1200 Series on a network

The MV-1200 Series' browser GUI provides a page for discovering remotes available on the network, which MV-1200 Series each one is assigned to (if any), and the ability to assign one or more of these remotes to the MV-1200 Series.

The TFT on the remote has similar menus to the MV-1200 Series' TFT where applicable - e.g. for displaying the status and selecting layouts.

Each hard button can be assigned to selecting a layout or triggering a timer, and the configuration for doing this is done from the MV-1200 Series' GUI.

The GPI inputs serve the same purpose, and again are configured from the MV-1200 Series' GUI, as are the GPI outputs which can be assigned to specific alarms.

Introduction

Remote panel communication with the MV-1200 Series on a network

2 Operation

Touch Screen LCD display

Though control and monitoring of a frame will primarily be via the browser GUI, the front panel LCD display can provide a quick way of checking the frame status.

Network settings can be modified and layouts can be recalled from here.

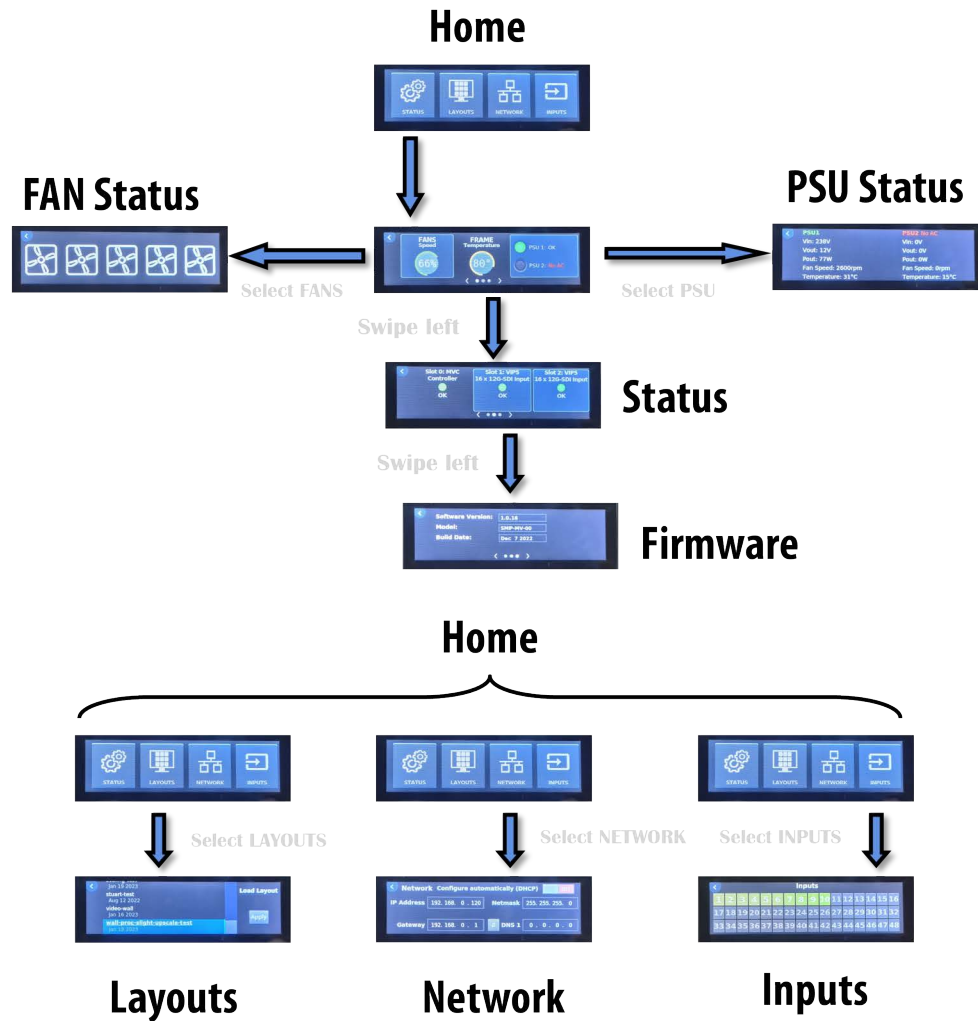

3 Web Browser User Interface

Graphical User Interface

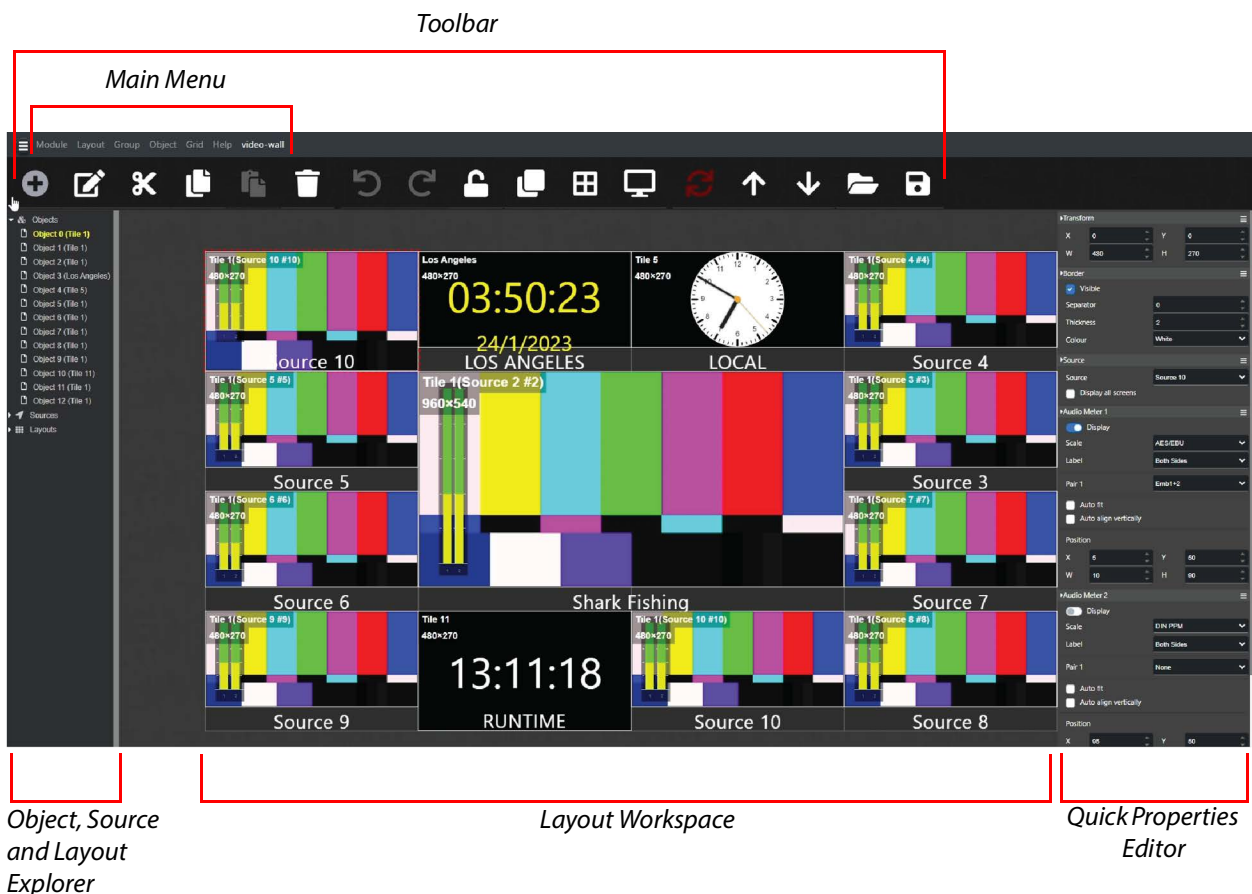

Fig. 3-1: MV-1200 Series Web Browser User Interface

The browser GUI interface comprises the following areas:

Perimeter	Description
Main Menu	Comprising the Module, Layout, Group, Object, Grid and Help menus from which all parameters of the multiviewer can be configured.
Layout Workspace	This is where Layouts are loaded for each video screen output. Existing Layouts can also be edited with Tile Objects added or removed, their Sources, Properties etc. modified as required. A Valid Workspace indicator flags any conflicts with new Tile Objects or changes made to existing tiles that are not compatible with the Layout being edited.

Perimeter	Description
Toolbar	A selection of the most commonly used functions to allow for quick and easy Tile layout and Tile Object editing.
Object Source and Layout Explorer	Allows Tile Objects and Sources to be configured as well as allowing Layouts to be selected.

Module Menu

Boards

This menu provides a clear overview of video processing card allocations. To access information about occupied slots by VIP5 video processing cards;

- 1 Navigate to **Module > Setup Module > Boards**

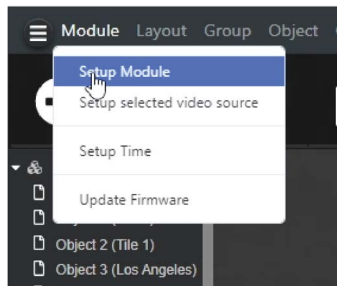

- 2 Click **"Save changes"** button to apply any modifications made or click **"Cancel"** button to discard changes and revert to the previous state.

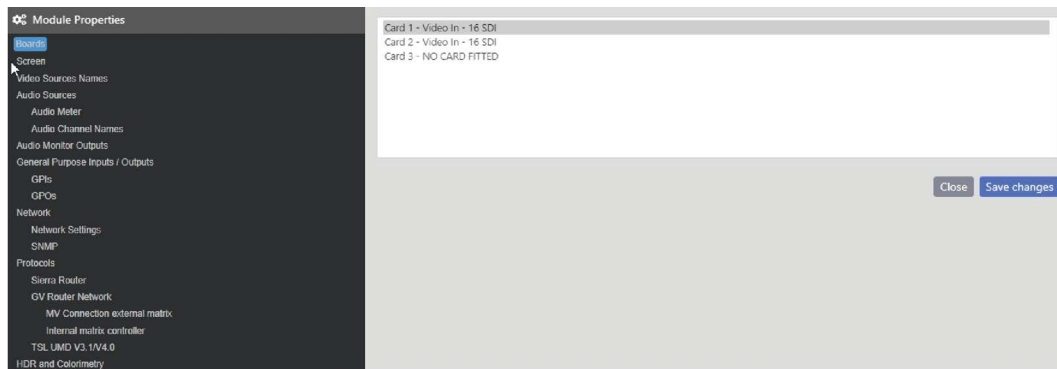

Screen

This menu displays the current screen resolution. To view the current screen resolution, navigate to **Module > Setup Module > Screen**.

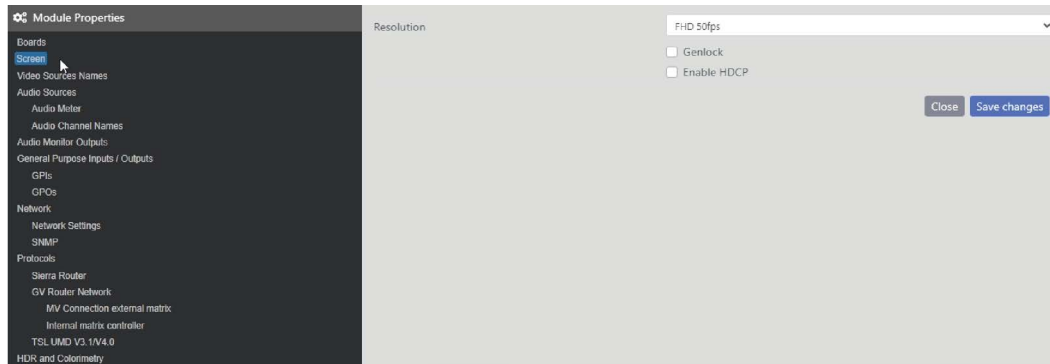

Click on the checkboxes to uncheck or disable Genlock and HDCP.

Setting	Resolution	Notes	Data Rate
UHD 50/59.94/60 fps	3840x2160P 50/59.94/60 fps	Progressive	12 Gbit/s
UHD 25/29.97/30 fps	3840x2160P 25/29.97/30 fps	Progressive	6 Gbit/s
FHD 50/59.94/60 fps	1920x1080P 50/59.94/60 fps	Progressive	3 Gbit/s
HD 50/59.94/60 fps	1920x1080i 50/59.94/60 fps	Interlaced	1.5 Gbit/s

Video Source Names

Navigate to **Module > Setup Module > Video Source Names** to enable the naming of sources.



Note

Default Source Names are same as Source ID i.e. Source 1, Source 2 etc.

Source names are not labels that get transferred to UMDs, they are simply user names to assist with identifying Sources within the browser control interface

Source names can be used to set the TSL Display address when using the TSL protocol for controlling UMDs and tallies (see TSL Protocol).

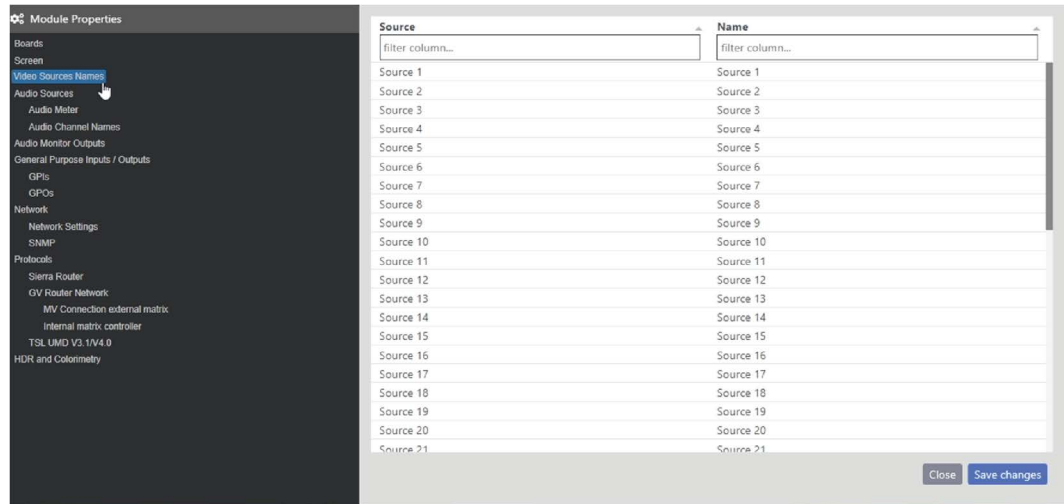

Audio Meter

This menu displays the audio meter. To view audio meter, navigate to **Module > Setup Module > Audio Sources > Audio Meter**

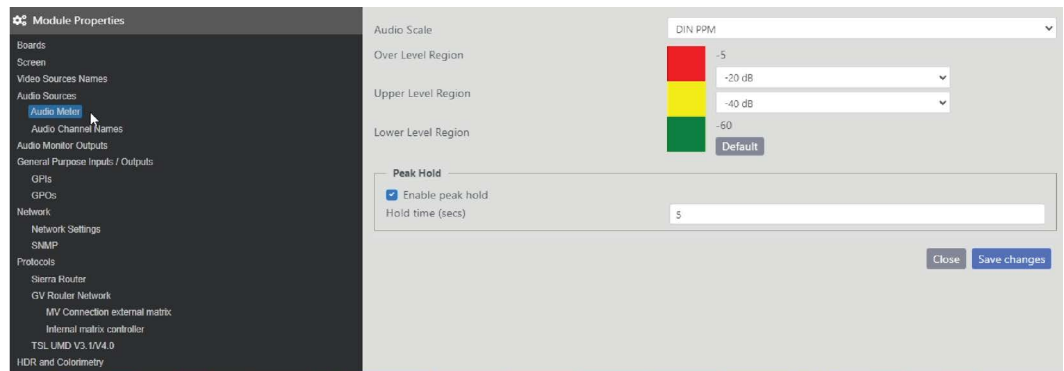

Setting	Description
Scale Regions	
Audio scale	Comprising the Module, Layout, Group, Object, Grid and Help menus from which all parameters of the multiviewer can be configured.
Layout Workspace	This is where Layouts are loaded for each video screen output. Existing Layouts can also be edited with Tile Objects added or removed, their Sources, Properties etc. modified as required. A Valid Workspace indicator flags any conflicts with new Tile Objects or changes made to existing tiles that are not compatible with the Layout being edited.

Setting	Description
Scale Regions	
Toolbar	A selection of the most commonly used functions to allow for quick and easy Tile layout and Tile Object editing.
Object Source and Layout Explorer	Allows Tile Objects and Sources to be configured as well as allowing Layouts to be selected.

Audio Channel Names

This menu enables Audio Sources to be named. To view Audio Channel Names screen, navigate to **Module > Setup Module > Audio Sources > Audio Channel Names**

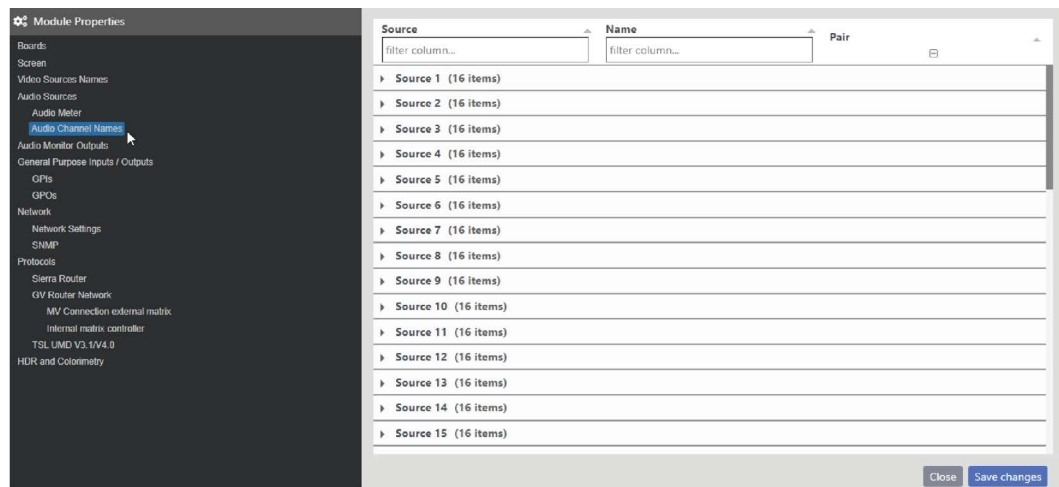

Note

Names can be assigned to each audio channel. Names entered here will be displayed below the meter bars if the labelling for the meter is set to Text in the Edit Object Properties of the tile that the meter is in.

Audio Monitor Outputs

This menu displays the audio meter. To view audio meter, navigate to **Module > Setup Module > Audio Sources > Audio Monitor Output**.

In The Stereo Monitor Out section, the Input SDI source and Stereo Pair can be assigned to the audio jack output.

In the SDI/HDMI out 1/2/3/4 embedded section, the Input SDI source and Stereo Pair can be assigned to the HDMI and SDI embedded outputs.

Section	Output	Input Source	Pair Number
Stereo Monitor Out	Output 1 + 2	Source 1	Channel 1 + 2
SDI/HDMI out 1 embedded	Output 1 + 2	Source 1	Channel 1 + 2
	Output 3 + 4	Source 1	None
	Output 5 + 6	Source 1	None
SDI/HDMI out 2 embedded	Output 1 + 2	Source 1	Channel 1 + 2
	Output 3 + 4	Source 1	None
	Output 5 + 6	Source 1	None
SDI/HDMI out 3 embedded	Output 1 + 2	Source 1	None
	Output 3 + 4	Source 1	None
	Output 5 + 6	Source 1	None
SDI/HDMI out 4 embedded	Output 1 + 2	Source 1	None

GPIs

This menu displays the GPI Input task. To view GPI input, navigate to **Module > Setup Module > General Purpose Inputs / Outputs > GPIs**

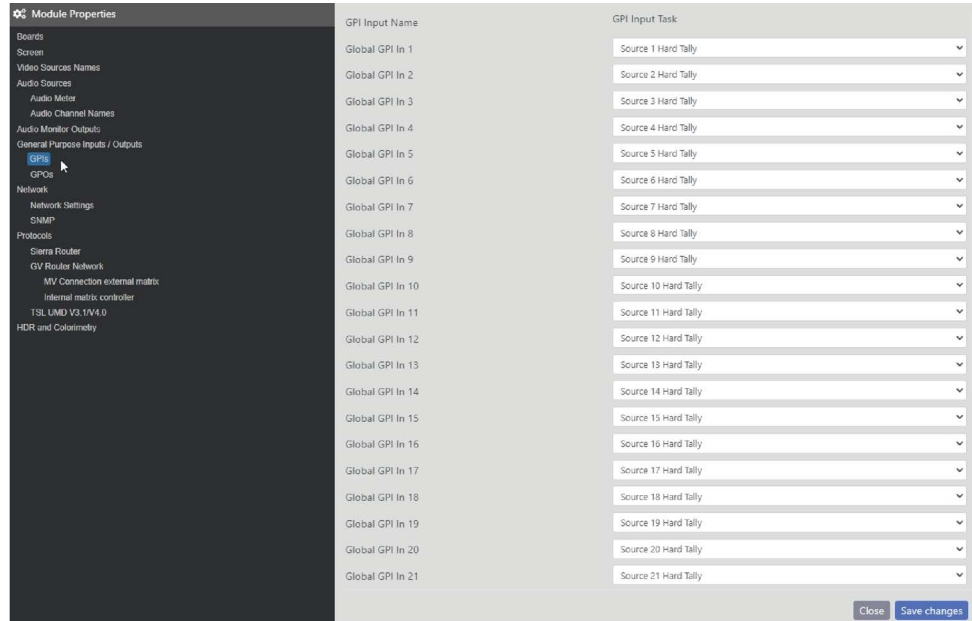

Assigns the task to execute on each Global or Video GPI in when activated.

Source X Hard Tally: turns on/off the tally relating to the Source in tiles that have the tally configured as Hardware, reference Chromatec document: Tally Configuration for more details on how to configure a tally.

For example, if Global GPI In 1 is configured for Source 2 Hard Tally and a tile that uses Source 2 has its tally Left-right sources set to Hardware 1 - Software 1 then the left tally in that tile will turn on when GPI In 1 is closed, off when GPI In 1 is open. If the tile has its tally set to Hardware 1 - Hardware 1 then both tallies will be controlled by Global GPI IN 1.

Timer x trigger: Multiple GPI inputs can be configured to control the resetting, pausing and resumption of timers, see Timer properties for more detail.

Global GPIs are located on the rear GPIO connector which has 32 GPI Inputs and 8 GPO outputs.

GPOs

This menu displays the GPO Output task. To view GPO output, navigate to **Module > Setup Module > General Purpose Inputs / Outputs > GPOs**

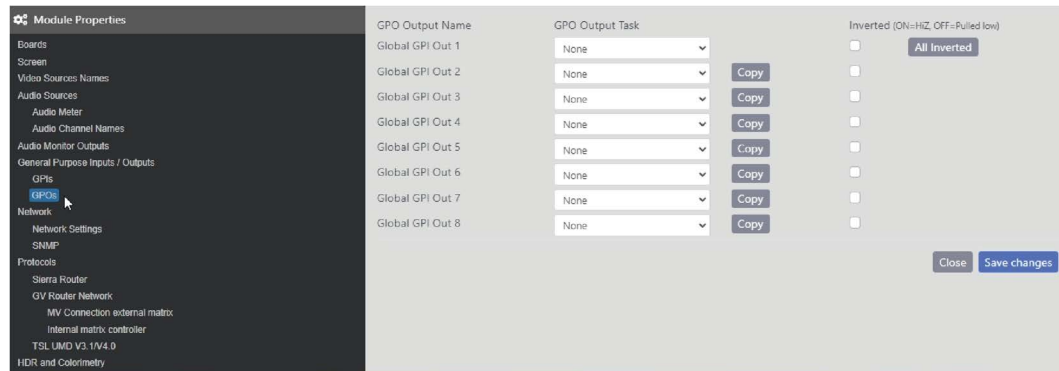

Setting	Description
GPO Output Task	Assign alarm condition to the selected Global or Video GPI Out X option. A selection of alarm conditions including None, Source X alarm, Video loss on any source etc are available from the pull-down menu.
Copy	Copy the previous GPO Output task, incrementing by 1, to the current GPO Output task. e.g. If Global GPI Out 2 is set to Source 2 alarm and the Copy button is pressed for Global GPI Out 3, it then gets set to Source 3 alarm.
Inverted	Inverts the polarity of the alarm output signal. When not inverted the output is pulled low when the alarm is active, high impedance when not active.

Network Settings

This menu displays the Network Settings. To view Network Settings, navigate to **Module > Setup Module > Network > Network Settings**

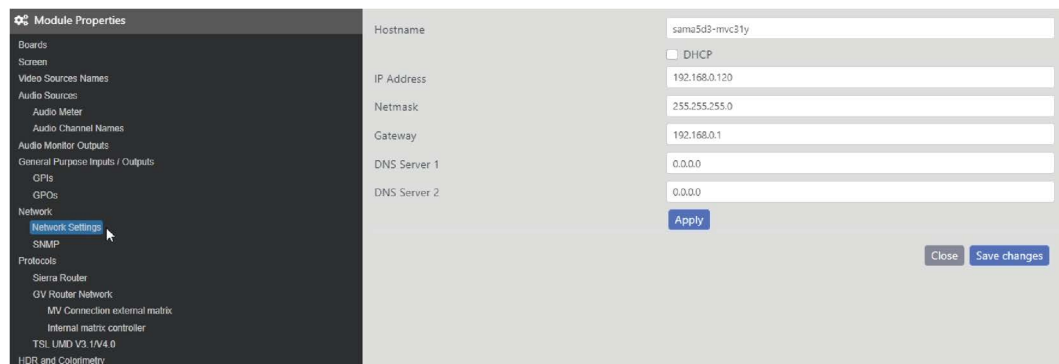

Setting	Description
Hostname	Enter a friendly name for the frame.
Use DHCP	Check to use DHCP for automatic acquisition of network settings. Uncheck for entry of fixed network settings.
IP Address	Enter fixed IP address.
Netmask	Enter network mask, if required.
Gateway	Enter gateway address, if required.
DNS Server 1	Enter DNS server address, if required.
DNS Server 2	Enter DNS server address, if required.

SNMP

This menu displays the SNMP tab. To view SNMP tab, navigate to **Module > Setup Module > Network > SNMP**

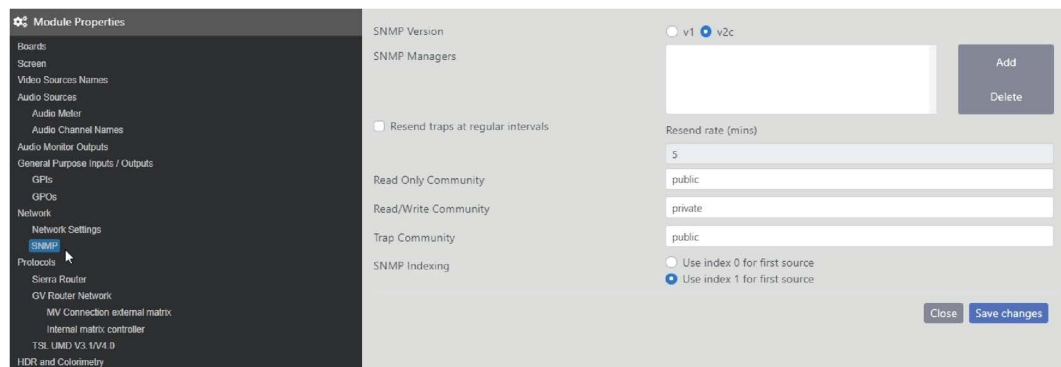

Setting	Description
SNMP Version	Check required SNMP version to use for traps
Add	Reveals dialogue for entering SNMP Manager IP address and adding to list. This is the list of managers that traps will be sent to.
Delete	Deletes selected SNMP Manager IP address from the list
Resend traps	Check to resend SNMP traps at regular intervals. The rate is also set here.
SNMP Communities	Enter the SNMP community names that managers will use for setting / getting OID values. The trap community is the one that will be used by the multiviewer when sending traps.
SNMP Indexing	Select whether SNMP indexing will start from 0 or 1.
Save MIB Files	Download the MIB module files from the multiviewer to use in the SNMP Manager.

Sierra Router

This menu displays the Sierra Router tab. To view Sierra Router tab, navigate to **Module > Setup Module > Network > SNMP**

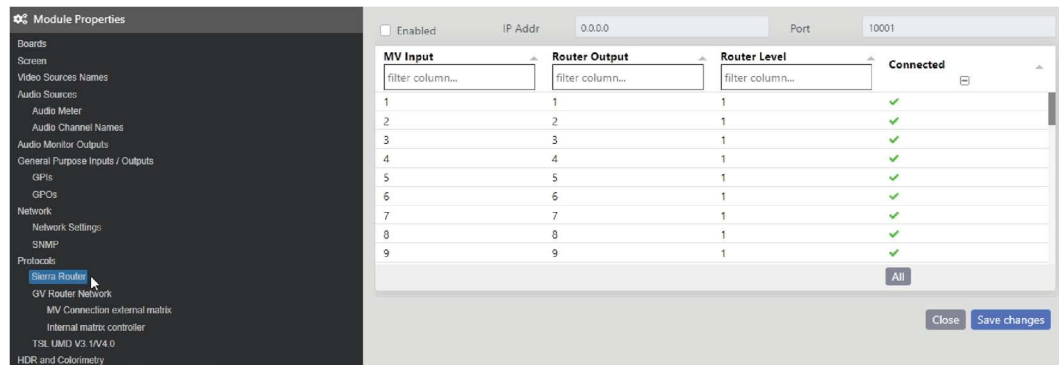

This allows the physical connections between the Sierra router and the frame, and the configuration of the TCP settings of a connection to a Sierra Video Systems Router.

Once the connection to the router has been established, the first row of UMDs in each video window will acquire the applicable source names of the router according to the source that is feeding the destinations connected to the multiviewer.

As cross-points are changed in the router, the UMDs will be updated.

Setting	Description
Enabled	Allows the multiviewer to connect to a Sierra router over Ethernet. (If this is ticked AND the serial port protocol is set to Sierra Router then the serial port will NOT attempt to connect to a router).
IP Address	The IP address of the Sierra router.
Port	TCP port to connect to the Sierra router with. Normally a Sierra router uses port 10001, however this can vary.
Physical connections from Router to Multiviewer	<p>This allows the wiring between the routers physical outputs and the multiviewers physical inputs to be configured.</p> <p>This table also applies to the serial port settings if the serial port is being used to communicate with the router.</p> <p>The columns are:</p> <ul style="list-style-type: none"> • MV Input – Lists all the inputs on the multiviewer. Fields in this column cannot be edited. • Router Output – In these fields, enter the physical output number of the router that is connected to the multiviewers input. • Router Level – In these fields, enter the level in the router that the output comes from. • Connected – Uncheck this field if the associated input does not come from the router.

GV Router Network

MV Connection External Matrix

This menu displays the MV Connection External Matrix tab. To view MV Connection External Matrix tab, navigate to **Module > Setup Module > Protocol > GV Router Network > MV Connection External Matrix**

This is for configuring the IP connections to GV router controllers, and the physical connections from GV routers to the frame. When communication with a GV router is established, the first row of UMDs in each video window will acquire the applicable source names of the router according to the source that is feeding the destinations connected to the multiviewer. As cross-points are changed in the router, the UMDs will be updated.

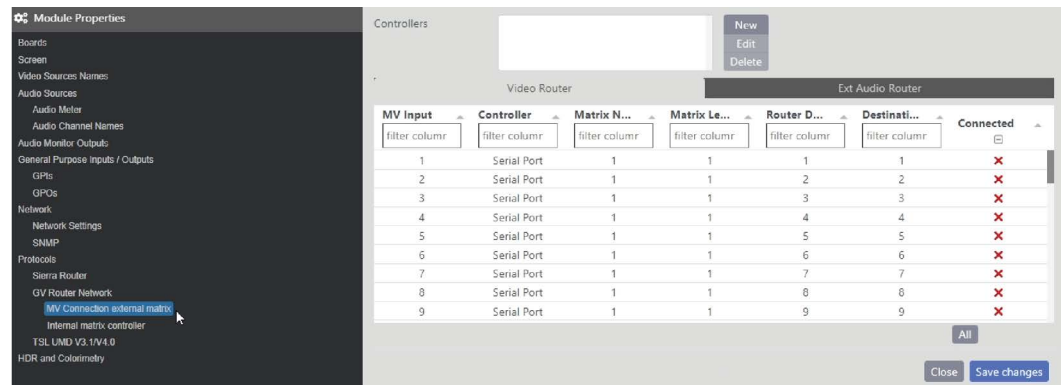

Setting	Description
Delete	Deletes a controller from the List
New or Edit button	Opens up the GV Controller Configuration window shown on the following page

Internal Matrix Controller

This menu displays the MV Connection External Matrix tab. To view Internal Matrix Controller tab, navigate to **Module > Setup Module > Protocol > GV Router Network > Internal Matrix Controller**

Generally this is more appropriate for frames with a router since it allows a GV controller to configure the router, but it can also be used to set source names (UMDs). Set the TCP port number(s) for the applicable GV SW-P-08 / SW-P-02 protocol being used here.

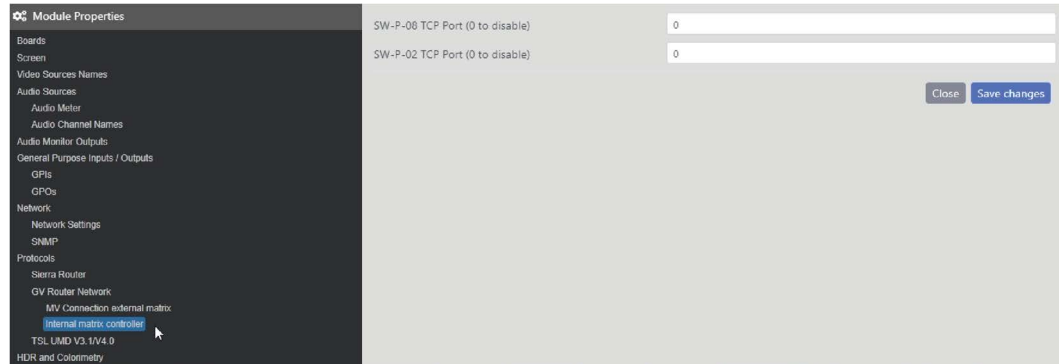

HDR and Colorimetry

This menu displays the HDR and Colorimetry tab. To view HDR and Colorimetry tab, navigate to **Module > Setup Module > HDR and Colorimetry**

This assumes that all inputs are the same colorimetry standard and the displays attach use a different standard and some transformation needs to be done (e.g. HDR BT.2100 inputs are being displayed on a SDR BT.2020 monitor). Only the gamma gets adjusted, so the transformation is not as accurate as 3D matrix transformation.

Generally, BT.709 is the colorimetry used in 2K HD SDR, BT.2020 is used in 4K HD SDR, and BT.2100 is used in HLG HDR.

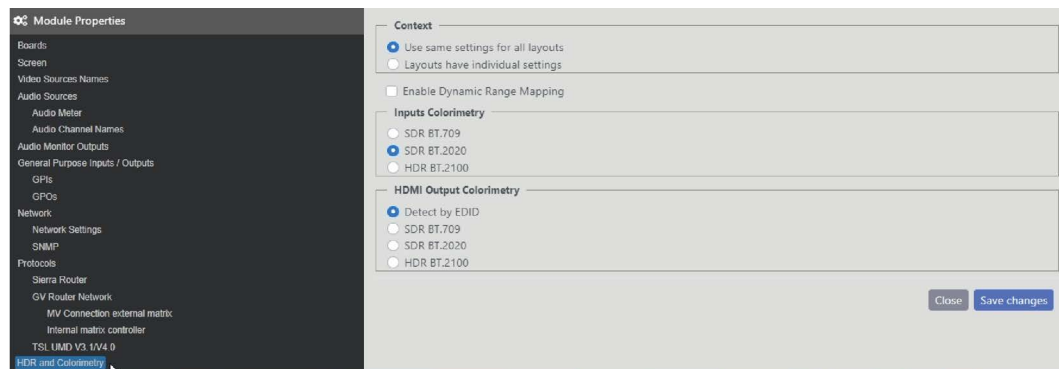

Setup Selected Video Source

This menu allows user to setup selected video source. Navigate to **Module > Setup Selected Video Source**

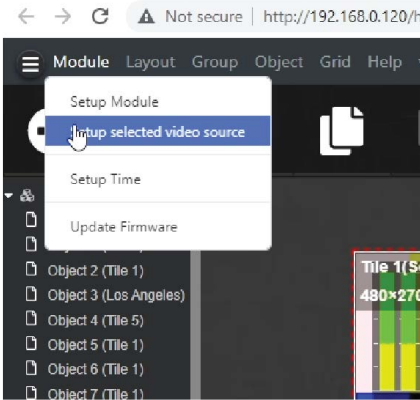

Audio Tab

Source	Audio Loss	Audio Over	Phase	Carrier Loss
Left 1	✓	✓	✓	✓
Right 1	✓	✓	✓	✓
Left 2	✓	✓	✓	✓
Right 2	✓	✓	✓	✓
Left 3	✗	✗	✗	✗
Right 3	✗	✗	✗	✗
Left 4	✗	✗	✗	✗
Right 4	✗	✗	✗	✗
Left 5	✗	✗	✗	✗

Setting	Description
Digital Audio Reference	Set the analogue to digital reference level when applying an analogue meter scale to a digital source, or a digital meter scale to an analogue source. It can be set within the range of -30 to -3 dBfs.
Analogue Audio Reference	Set the 0dB reference level with respect to analogue meter scales. It can be set within the range of -12dBu to +12dBu.
NOTE: Neither of the reference level adjustments above have any effect when digital audio is used with a digital scale.	
Alarms	<p>The thresholds for Audio Loss, Audio Over, and Antiphase alarms can be set, along with the alarm enabling of individual channels. The 16 channels listed here relate to the 16 embedded audio channels.</p> <p>e.g. Channels selected under Audio Loss will trigger an alarm when the audio level on the associated channel falls below the threshold set above.</p>
NOTE: This only selects which channels are potentially enabled for triggering alarms. The overall alarm type also needs to be enabled in the Alarm tab (see next section) – e.g. the Audio Loss alarm needs to be enabled in the Alarm tab for any of the selected Audio Loss channels to trigger an alarm.	

Alarm

The properties section allows each alarm to be set individually for onset and auto-clear delay, logging status and visibility in objects and lists.

Setting	Description
Select alarm	Click on an alarm to select it and then be able to set its Properties.
Enabled	Enables the selected alarm. NOTE: Enabled alarms change from red to a green circle.
Delay (seconds)	Set the delay before the alarm starts.
Automatic clearing	Enable the alarm to be cleared after the time set below.
Delay (seconds)	Set the delay before the alarm is automatically cleared.
Show in objects	Display alarms in objects
Send SNMP	Check to send SNMP trap in response to alarm

Notes	Description
Closed caption loss	This alarm will activate if closed captions are not present on the expected teletext page or closed captioning display service. e.g. If the teletext is set up to monitor page 801 for captions, and there are no captions on this page then the alarm will activate.
Teletext (WST) loss	This is only relevant if the source is SD-SDI, and will activate if there is no WST present at all (not just the magazine page set up to be monitored).
Teletext (OP-47) loss	This is only relevant if the source is HD-SDI, and will activate if there is no OP-47 present at all (not just the magazine page set up to be monitored).
D-VITC loss	This is only relevant if the source is SD-SDI.

Overscan

The Overscan tab allows adjustments to the amount of the image that is viewed in a tile when overscan is enabled within that tile. Each source can be individually adjusted.



Setting	Description
Overscan by the same amount on all edges	When this is checked only one adjustment will appear for adjusting all 4 edges that mark the boundary of the overscan region by the same amount. When unchecked, the following four menu items appear providing manual adjustment of the edges marking the overscan region.
Left/Width/Top/Height	Slider control. Adjusts the Left/Width/Top/Height of the overscan region.

Copy

The Copy tab allows Audio, Alarm and Overscan settings to be copied to other Sources. Multiple Sources can be selected by holding down the [Ctrl] key while clicking on the required Sources.

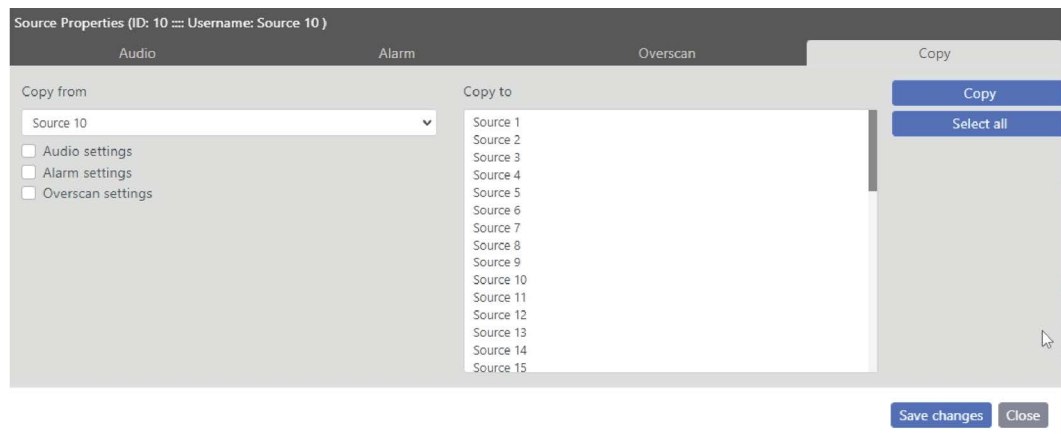

Setting	Description
Audio/Alarm/Overscan	Check to copy audio settings from selected source(s)
Select All/None	Select/Deselect all sources
Copy To	Copy settings to selected sources(s)

Setup Time

This menu allows user to setup time. Navigate to **Module > Setup Time**

Clock/date display data can be derived from several sources; the system clock, NTP synchronisation, LTC, or VITC from a chosen SDI input.

Setting	Description
Time	To set the clock source, go to the tab and select the desired source: Manual, NTP, LTC or VITC.
Timezone	The timezone should be set to the appropriate region before adjusting the clock.
NOTE: In the absence of any clock, the system time is used. A battery on the MVC3 card ensures the time data is retained if the unit is powered down.	
Manual	In this mode the time and date of the system clock will be shown and can be adjusted. Press the Get button to show the current time. To adjust the time enter the new time and date in the appropriate fields
NTP	In this mode the time is sourced from an NTP server (or multiple NTP servers can be entered) via the ethernet connection. Press the Add button to add a new server, and enter the host name or IP address of the new server.
LTC	In this mode the time is sourced from the LTC input. If no LTC is present then the system clock will be used (if LTC is present, but later disappears then the clock will continue advancing without any discontinuity).
VITC	The time can be sourced from VITC if that is present on any SDI input Select the chosen SDI source number that contains VITC. If no VITC is present then the system clock will be used (if VITC is present).

Update Firmware

This menu allows user to update firmware. Navigate to **Module > Update Firmware**

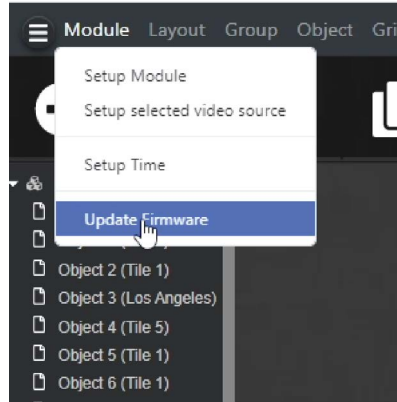

Select Choose-File to navigate to the firmware update package which has the following format, `mvc3-bundle-chromatec-version.raucb`

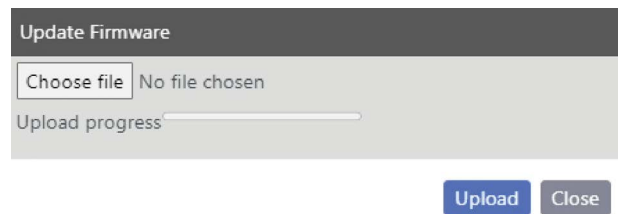

When the file has been selected click upload to begin the process. The ongoing progress of uploading and updating will be displayed and once complete the browser will reload the page.

The No-File-Chosen is an indicator that no file has been selected yet to start uploading. This will be the case when SFTP or equivalent has been used to transfer the firmware directly to the /data directory. The MV silently detects when the transfer has finished uploading and commences the firmware update automatically.

Layout Menu

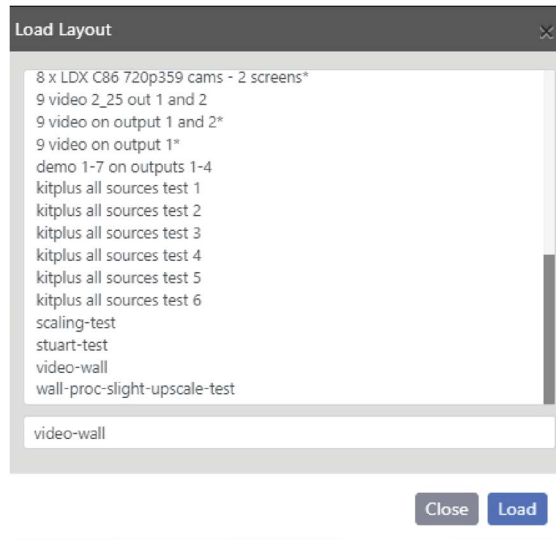

Setting	Description
New Layout	Offers to save the current layout before removing all objects from the editor workspace ready to create a new layout.
Load Layout	Loads a previously saved layout.
Save Layout	Copy settings to selected source(s)
Save layout as	Saves current layout with a different name
Delete layout	Delete a selected layout from the saved list.

Setup Layout

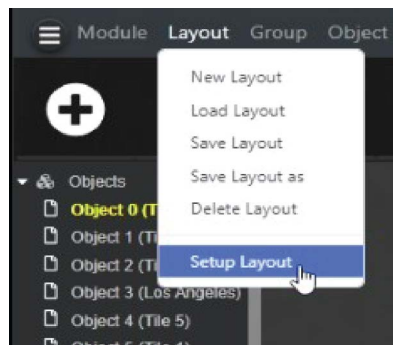

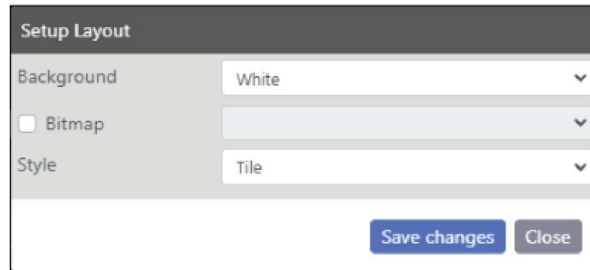

Setting	Description
Background	Set the display background colour.
Bitmap	Enables the selected bitmap from the pull down menu on the right to be used as the background. The picture should be in png format
Style	Select bitmap style: <ul style="list-style-type: none"> • Centre - centres bitmap • Tile - display bitmap in multiple tiles • Scale - scales bitmap to fit the display background

Group Menu

Select All/Unselect All

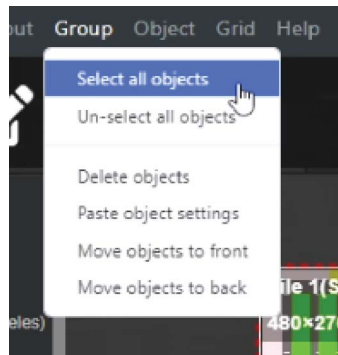

Setting	Description
Select All	All Tile Objects in the layout will be selected and can be operated on as a group.
Unselect All	All Tile Objects become independent and are no longer part of a group.
Cut objects	Removes all the Tile Objects in the group.
Paste objects	Pastes the Object that is on the clipboard to all Tile Objects in the group.
Move objects to front	Moves all Tile Objects in the group to the front.
Move objects to back	Moves all Tile Objects in the group to the back.



Object Menu

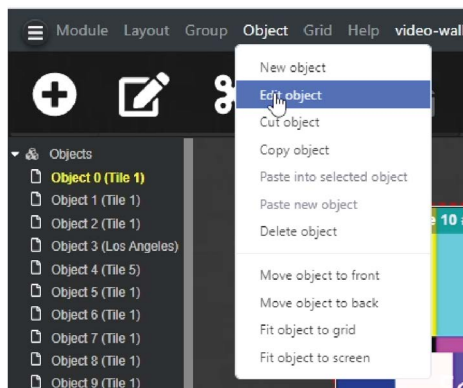

Setting	Description
New object	Creates a new Tile Object.
Edit object	Opens the Edit Object dialogue for the Tile Object that is currently selected.
Cut object	Cut the currently selected Tile Object.
Copy object	Copies the display properties of the currently selected Tile Object (excludes Source properties).
Paste object	Pastes the copied display properties to the currently selected Tile Object.
Paste new object	Creates a new object and paste to it any previously copied display properties.
Delete object	Deletes the currently selected Tile Object.
Move object to front	Sends the currently selected Tile Object in front of all other objects.

Setting	Description
Move object to back	Sends the currently selected Tile Object behind all other objects.
Fit object to grid	Sets the size of the currently selected Tile Object to the chosen grid pitch.
Fit object to screen	Set the selected Tile Object to full-screen size.

Edit Object

The Edit object menu is used to set up all the attributes of a Tile Object and can be accessed in the following ways:

- 1 From the Object menu (**Main menu > Object menu > Edit Object**).
- 2 Double clicking on the Tile Object to be edited.
- 3 Double clicking on the required Object in the Object source and explorer menu.

Tile & Transformation Tab

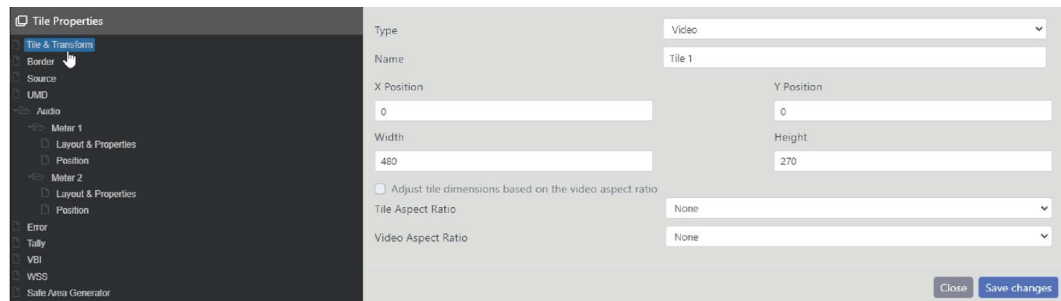

Setting	Description
Type	Defines object type. Choose from None, Video, Audio, Text, Logo, Clock and Timer.
Name	Name of the tile, can be up to 40 characters long
X Position/Y Position/ Width/Height	<ul style="list-style-type: none"> • Size and position of the tile can be altered by entering figures here, and any adjustments will be reflected in the outline of the rectangles drawn to represent the tiles. • Conversely, any resizing or repositioning of the tiles done graphically will be reflected in the figures presented here.
Adjust tile dimensions based on video aspect ratio	<ul style="list-style-type: none"> • Video Objects only • Locks the tile aspect ratio to match the Video Aspect Ratio setting so that no letter boxing or pillar boxing is required to maintain the correct aspect ratio. <p>NOTE: When this box is ticked Tile Aspect Ratio selection will be greyed out.</p>

Setting	Description
Tile Aspect Ratio	<ul style="list-style-type: none"> The aspect ratio of the tile can be set so that as either width or height are changed then the corresponding height or width will be automatically adjusted to retain the ratio. If None is selected the tile can be freely resized.
Video Aspect Ratio	<ul style="list-style-type: none"> Video Objects only. The video aspect ratio can be set so that as either width or height are changed then the corresponding height or width will be automatically adjusted to retain the ratio. Select 4:3 for SD, 16:9 for HD to set the aspect ratio based on the signal resolution. If None is selected the tile can be freely resized.

Border Tab

The border will be displayed as a shaded area on the tile in the editor workspace.

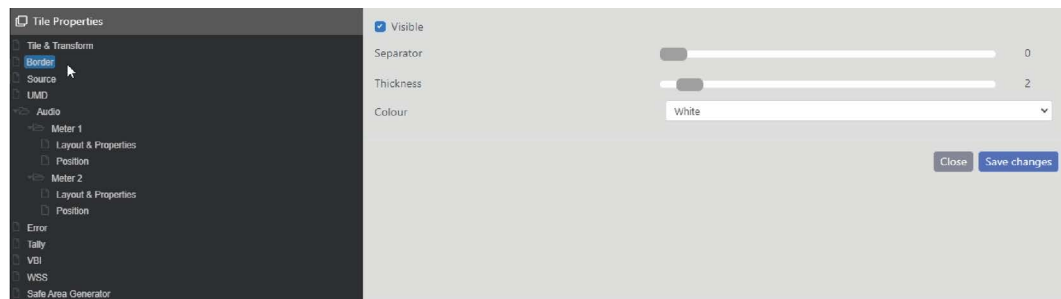

Setting	Description
Separator	Number of pixels separating the edge of the video content from the tile border.
Width	Pixel width of the border.
Colour	Colour of the border.
Visible	Turns the border on and off.

Source Tab

This tab only exists within the Properties tab of Video and Audio type tiles.

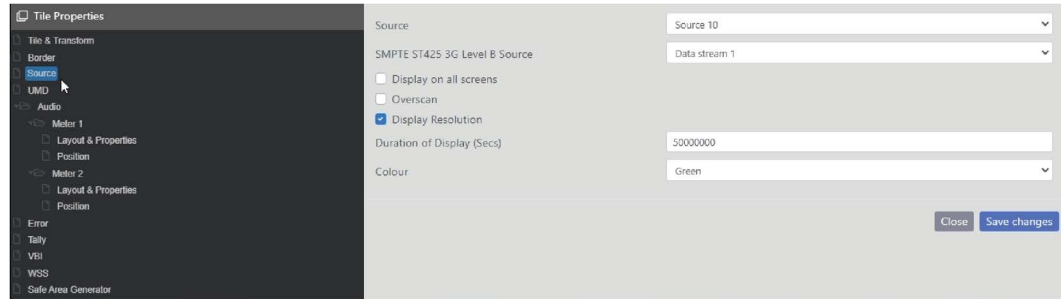

Setting	Description
Source	For a video tile, this selects the source of the video to display in the tile. For an audio tile, it selects the audio channels that have been set up to be associated with the chosen source.
SMPTE ST425 3G Level B Source	When the source is SMPTE ST425 (3G-SDI) Level B Dual Stream there are two images in the link, this selects which image to display.
Display on all screens	This will display the video tile on both outputs. The tiles remain locked to each other on both outputs (moving the tile on one screen will also move it to the same position on the other screen).
Overscan	Tick to overscan the video image by the amount set in the Overscan tab
Display resolution	Ticking this box will display a message in the top left corner of the tile indicating the format and resolution of the video input.
Duration of display	If display resolution is enabled, this sets the number of seconds that the message will be displayed after a change in the format or resolution occurs.
Colour	If display resolution is enabled this sets the colour of the video input format message.

UMD Tab

Under Monitor Display (UMD) information may be generated from remote sources via the LAN using browser software operating on a remote PC, or via the RS232/422 port using TSL or other protocols. Up to two lines of UMD text can be left, centre, or right justified and may be placed anywhere in the tile.

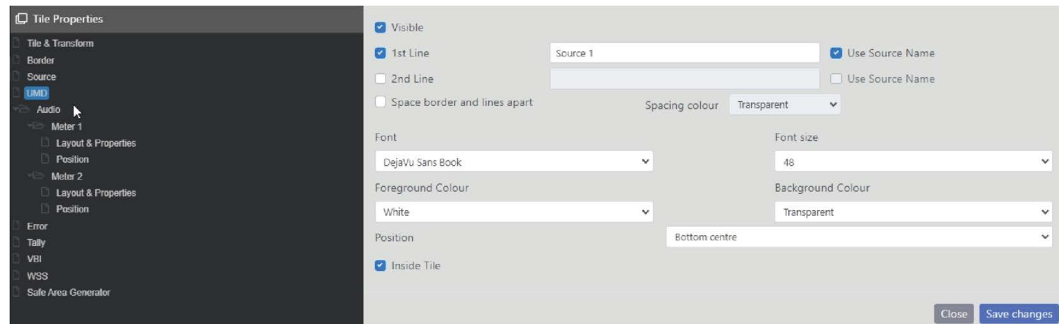

Setting	Description
Text 1st line/ Text 2nd line	Enter UMD text (via keyboard).
Use source name	Enables the use of the assigned source name for the UMD text.
Font	Choose font of the text.
Font size	Choose the font-size of the text.
Foreground colour	Sets the colour of the text.
Background colour	Sets the colour of the UMD background.
Position	Position of UMD relative to the tile.
Separator	Places a separator between the UMD and the objects image and also between each line of text. Using the pull down menu, the colour of the separator can be chosen.
Inside tile	Places the UMD bar inside the tile (within the active picture).
Transparent on video	Enables the transparency of the UMD when it is in the picture area.
Transparency level	Sets the transparency of the UMD when it is in the picture area.
Visible	Enables the UMD to be seen on the tile.

Audio Meter (Layout and Properties) Tab

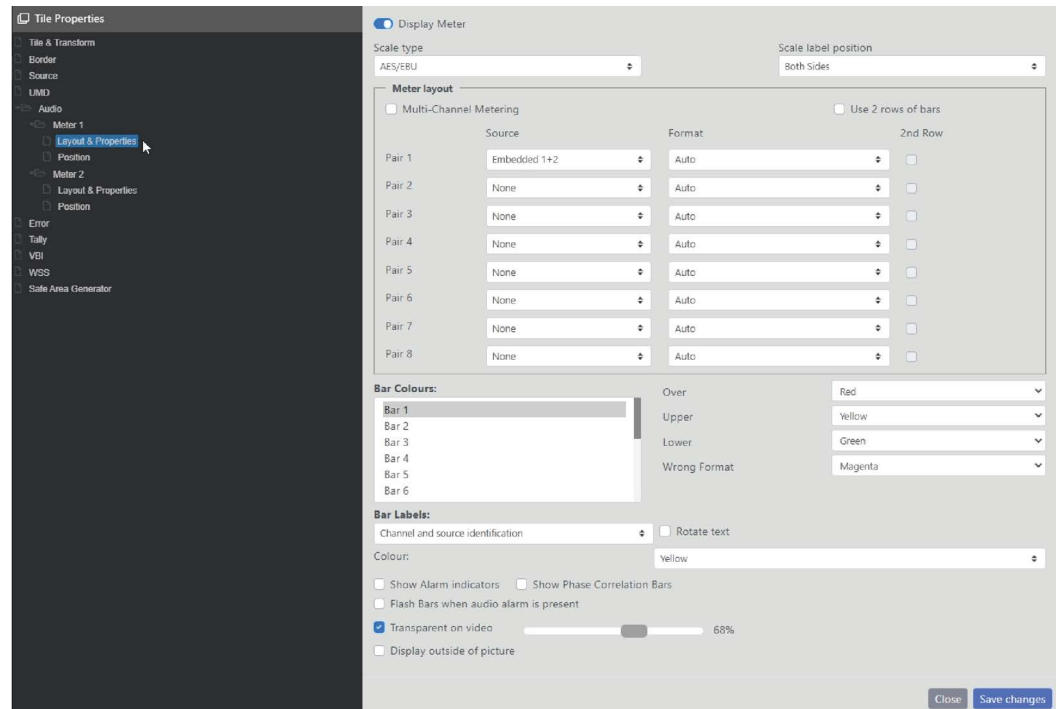

Setting	Description applies to Meter 1 and Meter 2
Display meter	Enables each audio meter groups.
Scale type	Sets the scale type of all the audio meter bars on display in this meter. When both meters are displayed, the scale type for meter 1 is also used for meter 2.
Scale label position	Sets the positioning of the scale labelling on either side of the meter
Multi-channel metering	When enabled the following settings are required.
Use 2 rows of bars	Tick to split into 2 sections. For sources that are to appear in the bottom row, tick the 2nd row box next to the pair setting. When unticked only one row of audio meter bars is displayed
Audio source	Sets the source to display in each of the 16 bars of the meter. These allow up to 8 pairs to be configured for displaying in any order. Set to None to turn a pair off, or select Embedded or External audio pair as the source.
Audio format	This selects the expected audio format. If set to auto, then the number of bars that are displayed for this pair depends on the decoded format. When Dolby E meter segment metadata is the source, there may be up to 8 channels to display for one source pair. If set to a fixed format (PCM, Dolby E 5.1 +2 etc.) then the number of bars displayed will be fixed. If the decoded format differs from the one that is set here then the levels will still be displayed (for the appropriate number of channels), however the "wrong format" colour will be used for the bars. (See Wrong Colour format setting).
2nd row	Select this if the meter is to be split into 2 sections. For sources that are to appear in the bottom row, tick the 2nd row box next to the pair setting.
Bar Colours	Selects bar to which the colour of the over, upper, lower range, and wrong format applies.

Setting	Description applies to Meter 1 and Meter 2
Over Colour	Sets the over range colour for the bar selected in the Bar Colours control.
Upper Colour	Sets the upper range colour for the bar selected in the Bar Colours control.
Lower Colour	Sets the lower range colour for the bar selected in the Bar Colours control.
Wrong Format	Not applicable if Audio Format is set to Auto. Sets the colour that will be used for the bar if the audio format disagrees with the format set in the Audio format field.
Bar labels	Sets the display of the bar labels to either an enumerated format, or the labels as entered for the respective channels, or off. When labels entered for the respective channels is chosen (the Text option), it uses the labels entered via the Module > Audio Channel Names menu.
Rotate Text	Rotates the label characters by 90 degrees and draws the labels from top down (as opposed to characters being upright and drawn from left to right).
Colour	Sets the colour of the bar labels.
Show alarm indicators	Enables the alarm indicators at the top of the bars.
Flash bars when an audio alarm is present	Enables the flashing of the audio bars when an audio alarm is detected, (to attract attention).
Transparent on video	Enables the transparency of the meter bars when they are on the in-picture area.
Transparency level	Sets the transparency of the audio bars when they are on the in-picture area.
Display outside of picture	Reduces the width of the video portion of the tile and positions the meter against the inner edge of the tile so that it is not overlapping the video. NOTE: to maintain the desired aspect ratio of the video, go to the WSS tab, select WSS/AFD for the mode, tick the Auto size video image, and set the Default aspect ratio to the applicable value.

Audio Meter (Position) Tab

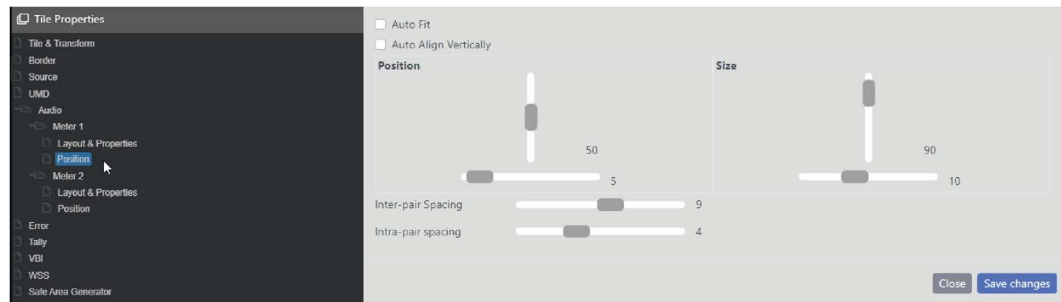

Setting	Description applies to Meter 1 and Meter 2
Auto fit	Automatically scales the meter to fit into the whole tile. NOTE: The Position and Size settings are disabled when this is selected.
Auto align vertically	Automatically align the base and height of audio meters that are in tiles of the same vertical position and height. When audio meters are configured they might have different heights below the meter region (e.g. the labels might be different lengths for different meters). They can also have different heights above the meter region (e.g. some might have alarm indicators turned on, others might not). This results in the vertical positioning of the bar graphs of each meter to differ. This feature will align vertically all the bargraphs of different meters. NOTE: It only aligns meters in tiles that are in the same vertical position and have the same height.
Position	Sets the vertical and horizontal position of the meter within the window (disabled when Auto fit is ticked).
Size	Sets the vertical and horizontal size of the meter within the window (disabled when Auto fit is ticked).
Inter-pair spacing	Sets the number of pixels appearing between two meter bars belonging to different pairs.
Intra-pair spacing	Sets the number of pixels appearing between two meter bars belonging to the same pair.

Error Tab

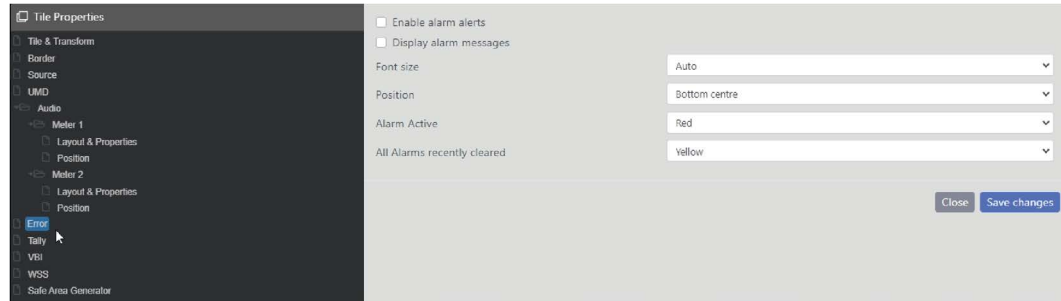

Setting	Description
Enable alarm alerts	Enables alarm indications within the tile.
Display alarm messages	When enabled all the alarms that are currently triggered or have recently been cleared will be displayed in the tile. NOTE: Only one alarm type gets displayed at a time, it will cycle through them if multiple alarms are present.
Font size	Select the font size. NOTE: If Auto is selected the alarm text is automatically sized to suit the tile it is being displayed on
Position	Sets the position of the meter within the window
Alarm active	Sets the border colour of the tile when an alarm triggers. Also applies to the colour of alarm messages for alarms that are active.
All alarms recently cleared	Sets the border colour of the tile when no alarms are currently triggered, but some have recently cleared but not reset yet. This also applies to the colour of alarm messages for recently cleared alarms.

Tally Tab

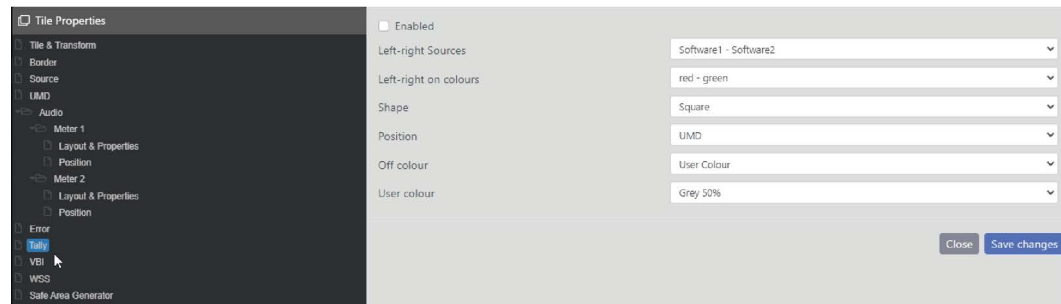

Setting	Description
Enabled	Turns the display of the tally on/off.
Left-right sources	<p>Select Hardware or one of two Software tallies. The Hardware tally is the GPI tally that has been set up for the video source of the tile. This GPI-to-source assignment is configured in the GPI inputs tab. For each applicable GPI, select a Source....Hard Tally here).</p> <p>The two Software tallies operate in accordance with the TSL protocol or the Open Protocol tally commands. TSL has up to 127 display addresses; each address comprising 4 tallies and a UMD. The address assigned to a source depends on how the TSL protocol has been configured. For the Open Protocol control, see setsourcetally in Open Protocol.</p> <p>Each video window can use the first 2 tallies of its display address to trigger the 2 tallies available in its UMD bar, or the border tally if set up appropriately.</p>
Left-right on colours	Select red-green, green-red, red-red and green-green.
Shape	Select Fill or Square. When set to Square the left-right colour settings apply to the 2 squares displayed on the left-right sides of the UMD. When set to Fill the UMD and / or border (depending on the Position setting) will be filled with the left or right colour, depending on which tallies are triggered. The left tally has the highest priority - if it is triggered then the UMD/border will be the left colour. Otherwise, if the right tally is triggered then the UMD/border will be the right colour.
Position	Select UMD, Border or UMD-border.
Off colour	Sets the disabled colour to either UMD colour, Border colour, or the User colour.
User colour	Selects disabled colour if Off colour is set to be User Colour.

VBI Tab

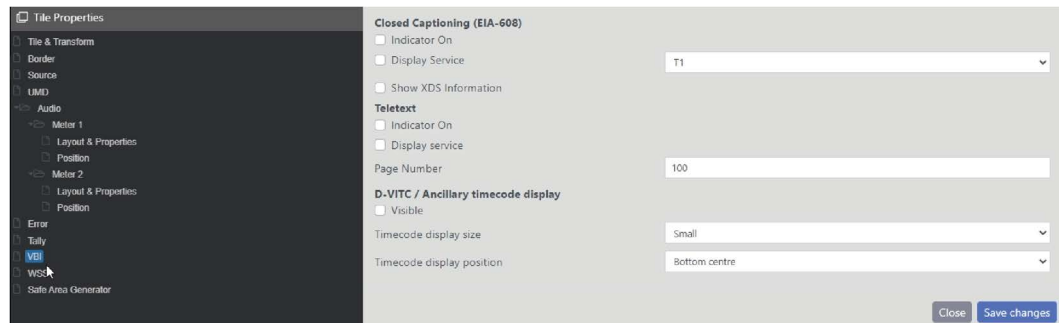

Setting	Description
Closed Captioning (EIA-608)	NOTE: These settings apply to composite NTSC inputs only (line-21 closed captions)
Indicator on	Enables a “CC” indicator to be shown in the tile if the selected closed caption type is present.
Display service	Displays the closed caption text in the tile when enabled and the pull down menu selects the type of service to be displayed.
Show XDS information	Shows the information contained in the extended data services
Teletext	NOTE: These settings apply to composite or SDI video that contains WST subtitles, and SDI video that contains OP-47 teletext subtitles.
Indicator on	Enables the indicator to be shown if teletext is present in the video. Displays “WST” or “OP-47”, depending on the type present or no indicator if none present.
Page number	Selects which teletext page is to be viewed.
D-VITC / Ancillary timecode	NOTE: This is only available on SDI inputs.
Visible	Turns on a timecode display in a fixed position near the bottom centre of the tile within the video. The display will start to be cropped when the tile is 150 pixels or less wide. For each input it is possible to display either the Ancillary Timecode (from SD- HD- or 3G-SDI inputs) or D-VITC (from SD-SDI inputs only). If multiple sources of timecode are present in a video source then the timecode selected for display in order of priority is: Ancillary VITC, Ancillary LTC and D-VITC.
Timecode display size	Select the size of the timecode to be displayed
Timecode display position	Select the position of the timecode to be displayed
D-VITC Note	D-VITC is only available on SD sources as there is currently no standard for HD sources. Ancillary Timecode is available on both SD and HD sources.
WST Teletext Note	WST Teletext can only be decoded from Composite inputs.
CC Note	Closed Caption pages of Teletext using the OP-47 standard can be displayed on SDI inputs

WSS Tab

This tab only exists in tiles that are of Video type. If VBI data is present on a video input and the video is an SDI source then the WSS/AFD data can be used to control Aspect Ratio.

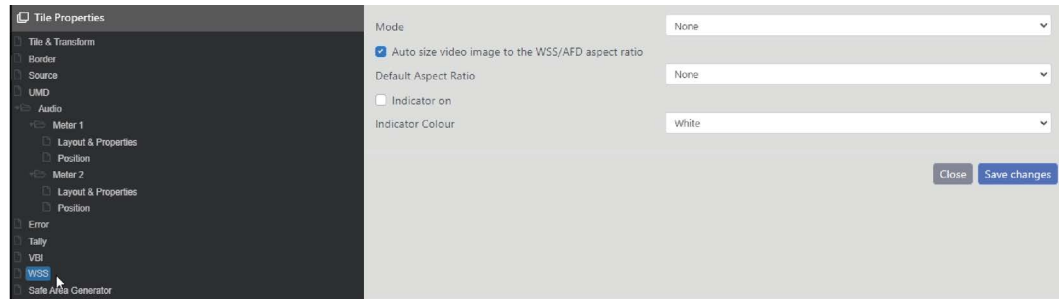

Setting	Description
Mode	Selects the type of WSS/AFD to decode, select None, WSS, AFD or WSS/AFD
Auto size video image to the WSS/AFD aspect ratio	When enabled, the aspect ratio of the video will automatically respond to any changes in the selected WSS or AFD information. When unticked the default video size is defined by the Video Aspect Ratio setting on the Edit object - Type tab
Default aspect ratio	Chooses the aspect ratio to use when the correct one is unknown (for example if WSS or AFD is not present). Select 4:3 for SD, 16:9 for HD.
Indicator on	When enabled this will present an indicator in the tile if there is aspect ratio information available.
Indicator colour	Sets the colour of the indicator text

Safe Area Generator Tab

This tab only exists in tiles that are of Video type.

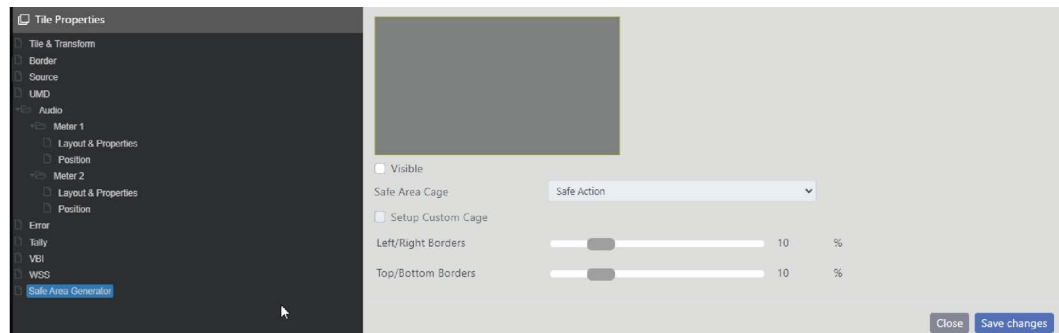

Setting	Description
Visible	When ticked, this will show the safe area outline in the video
Safe Area Cage	If a pre-set safe area cage is to be shown then choose the appropriate one from this list.
Setup Custom Cage	When checked a custom safe area cage can be drawn using the vertical and horizontal
Vertical Borders	Adjust the vertical borders of the safe area. The slide bar can be used, or numbers manually
Horizontal Borders	Adjust the horizontal borders of the safe area. The slide bar can be used, or numbers

Grid Menu

Accessible from the Main menu, the Grid menu enables the layout workspace to be defined by a grid for ease of aligning Tile Objects in a regular arrangement. The Size Object to Grid function in the main toolbar works in conjunction with this feature and automatically sizes the currently selected tile to the cell size of the grid that has been set.

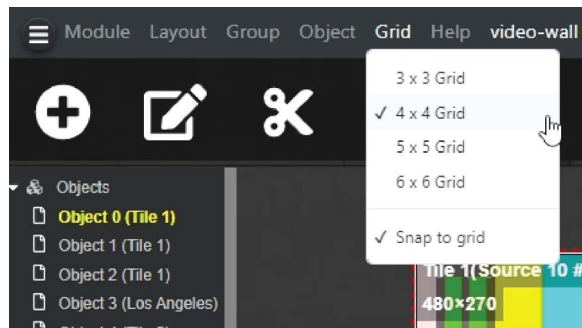

Setting	Description
3 x 3, 4 x 4, 5 x 5, 6 x 6 grid	Check to display the required grid
Snap to Grid	Enables tiles to be snapped to the nearest grid position when repositioning. The tip left corner of the tile is anchored to the top left corner of the grid position.

Help Menu

About

Help is found on the Main menu. The current system status and firmware revisions of all cards and rears detected in the chassis and is accessed from **Help > About**

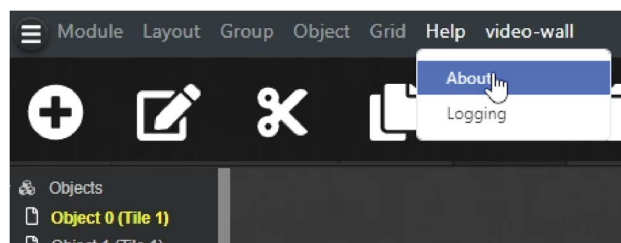

Web Browser User Interface

About



Setting	Description
About	Shows in numerical order starting from Slot 0, the main card type fitted in that slot along with its firmware revision. For all input cards, the type of rear fitted along with its firmware revision is also shown. To view all the cards in the chassis, it may be necessary to use the righthand scroll bar and scroll downwards.

Logging

Logging

```

Jan 25 10:43:13 user.info kernel: sii9136 hdmitx-1: tx_read_edid_block 0
Jan 25 10:43:13 user.info kernel: sii9136 hdmitx-1: EDID version 1.3, 1 extension blocks, vip 0x80
Jan 25 10:43:13 user.info kernel: sii9136 hdmitx-1: tx_read_edid_block 1
Jan 25 10:43:13 user.info kernel: sii9136 hdmitx-1: EDID extension block type CEA-861 revision 3
Jan 25 10:43:13 user.info kernel: sii9136 hdmitx-1: EDID supports basic audio, enabling HDMI mode
Jan 25 10:43:13 user.info kernel: sii9136 hdmitx-1: set_res: pixclk=148500000 vfreq=50 htot=2640 vtot=1125
Jan 25 10:43:13 user.info kernel: sii9136 hdmitx-1: TX TMDS ON
Jan 25 10:43:13 user.warn multiviewer: No SendToMV handler for module0.audioOut
Jan 25 10:43:16 user.err multiviewer: Unable to open /data/etc/ntp_dis.conf
Jan 25 10:43:18 user.err multiviewer: Unable to open /data/etc/ntp_dis.conf
Jan 25 10:43:19 user.info multiviewer: Slot 2:fpga1: feedin phase success, start=231 end=334 pos=282
Jan 25 10:43:20 user.info multiviewer: Slot 1:fpga0: feedin phase success, start=130 end=223 pos=176
Jan 25 10:43:20 user.info multiviewer: UpdateDisplay reason 4: I/O card change
Jan 25 10:43:20 user.info multiviewer: Master slots: video=2, ancillary=2
Jan 25 10:43:21 user.info multiviewer: Slot 1:fpga1: feedin phase success, start=1 end=102 pos=51
Jan 25 10:43:34 user.warn multiviewer: No ReadFromMV handler for module0.audioOut
Jan 25 10:43:41 user.info multiviewer: MVC temperature: FPGA = 43, thermistor = 15
Jan 25 10:44:11 user.info multiviewer: Free memory = 414652kB
Jan 25 10:44:41 user.info multiviewer: MVC temperature: FPGA = 53, thermistor = 18
Jan 25 10:45:12 user.info multiviewer: Free memory = 414636kB
Jan 25 10:45:42 user.info multiviewer: MVC temperature: FPGA = 57, thermistor = 20
Jan 25 10:46:12 user.info multiviewer: Free memory = 414716kB
Jan 25 10:46:42 user.info multiviewer: MVC temperature: FPGA = 60, thermistor = 21
Jan 25 10:47:12 user.info multiviewer: Free memory = 414208kB
Jan 25 10:47:42 user.info multiviewer: MVC temperature: FPGA = 60, thermistor = 22
Jan 25 10:48:13 user.info multiviewer: Free memory = 414232kB
Jan 25 10:48:43 user.info multiviewer: MVC temperature: FPGA = 60, thermistor = 22
Jan 25 10:49:13 user.info multiviewer: Free memory = 414232kB
Jan 25 10:49:43 user.info multiviewer: MVC temperature: FPGA = 60, thermistor = 22
Jan 25 10:49:46 user.err multiviewer: Unable to open /data/etc/ntp_dis.conf
Jan 25 10:50:14 user.info multiviewer: Free memory = 414232kB

```

[Download all](#)
[Refresh](#)

Setting	Description
Download all	Navigate to a network location to save the system log.
Refresh	System log is refreshed with current settings.

4 Specifications

Audio

Audio meters	48 Fully configurable tiles with left/right or split meters All pairs of embedded audio can be displayed.
Embedded Audio on Outputs	SDI or HDMI outputs can be individually configured to include up to 4 pairs of embedded audio from any of the inputs.
Audio Monitoring Out	1 Pair of embedded audio from a

Reference

Genlock reference	BB/Tri-level sync nominal 1V pk-pk 75Ω HD BNC
Time reference	LTC input or NTP (network protocol) Nominal 1V pk-pk

Source Data

Subtitles	WST on SD-SDI or OP-47 on HD-SDI
Aspect ratio	Automatic adjustment using AFD decoding
Timecode	D-VITC and Ancillary TC SD/HD-SDI
User Logo	PNG format with storage capacity up to 50MByte
Idents	Idents, text boxes and any TrueType fonts

Alarms

Alarms	Video, audio, and metadata (CC, WST, OP-47, D-VITC, ATC loss and CRC errors).
Alarm Outputs	Hard and Soft Alarm outputs Soft Outputs via LAN and/or SNMP
Tallies	Hard (GPIO Input) and Soft Tally input support. 2 tallies per tile. Maximum 32 x GPIO Inputs can be assigned.
Under monitor displays	Under Monitor Display (UMD) information may be generated from remote sources via the LAN operating on a remote PC or serial using TSL/Open protocols.

Clocks/Dates	Analogue and Digital Clocks with foreground and background colours. Date display with digital clock. Clock/date display data can be derived from several sources; the system clock, NTP synchronisation, LTC, or VITC from a chosen SDI input. Time-zone and offset settings.
Timers	Programable Countdown Colour, Transition Colour and Destination Colour. Countdown timer may be setup to start at a certain time of the day or controlled by GPIO Inputs. Timer modes for single and dual GPIO inputs supporting Pause, Resume and Reset.
Battery Backup	A non-rechargeable battery ensures the time and date settings are retained if power is lost or the unit is powered down.

Environmental

Temperature	0°C to 40°C
Humidity	30% to 90% (no condensation)
AC/DC Power Module	(90VAC ~ 264VAC), 50/60 Hz Safety Compliance: CB, CE, CCC, cUL, UL, TÜV
Max. Power Consumption	151.7W at 200-240VAC, 50Hz, 0.68A
Compliance	EMC – Emissions EU: EN55103-1 USA: FCCR 47 CFR: 2009, Part 15, Sub-part B (Class A) EMC – Immunity EU: EN55103-2. Safety EN: EN60950-1 USA: Tested to UL1419 (3rd Edition) Hazardous Material UK: RoHS-6 – Complies with EU Directive

GPIO Inputs

GPIO Input Signals

Up to a maximum of 32xGPIO Inputs, 8xGPIO Outputs may be assigned.

A High-density 44-way D-type socket with the following pinout is used.

GPIO Inputs	Pin	GPIO Inputs	Pin	GPIO Inputs	Pin	GPIO Inputs	Pin
GPI1	1	GPI9	9	GPI17	17	GPI25	25
GPI2	2	GPI10	10	GPI18	18	GPI26	26
GPI3	3	GPI11	11	GPI19	19	GPI27	27
GPI4	4	GPI12	12	GPI20	20	GPI28	28
GPI5	5	GPI13	13	GPI21	21	GPI29	29
GPI6	6	GPI14	14	GPI22	22	GPI30	30
GPI7	7	GPI15	15	GPI23	23	GPI31	31
GPI8	8	GPI16	16	GPI24	24	GPI32	32

GPIO Input Circuit

The GPIO input circuit is shown below for a single input. The GPIO input is triggered when the input is shorted to GND - typically from an open collector driver. Each input is pulled up to 3.3V with a 10K resistor.

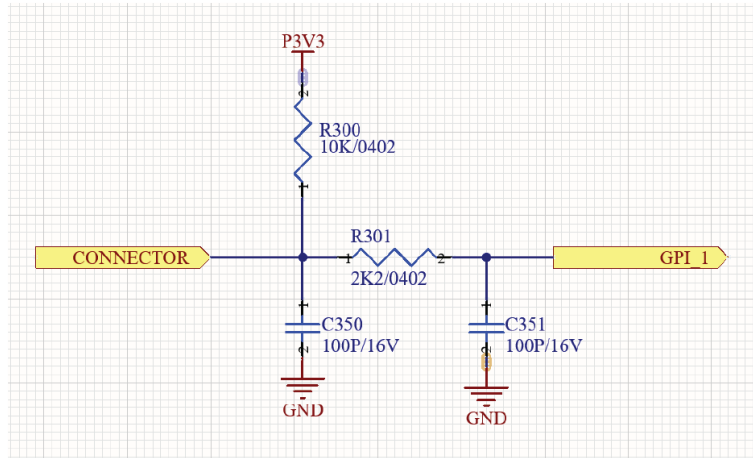

Description	Activated by external contact closure to GND
Pull-up Voltage	3.3 Volts
Source current	0.33mA when input shorted to GND
Low-level activation	0.8V maximum
Connector	DB-44

GPIO Outputs

GPIO Output Signals

Up to a maximum of 8xGPIO Outputs.

A High-density 44-way D-type socket with the following pinout is used.

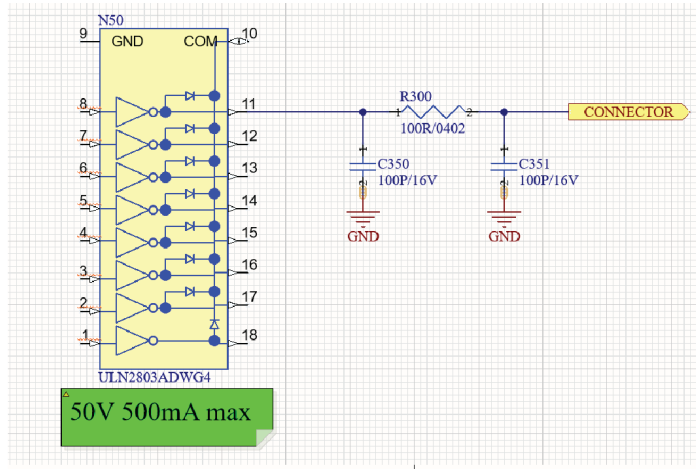

GPIO	Pin
GPI1	32
GPI2	33
GPI3	34
GPI4	35
GPI5	36
GPI6	37
GPI7	38
GPI8	39

DB-44 GND	Pin
GND	40
GND	43
GND	44

GPIO Fused Power

A +5V output with 200mA PTC fuse is provided on pin 31 that can be used to power an external receiver.

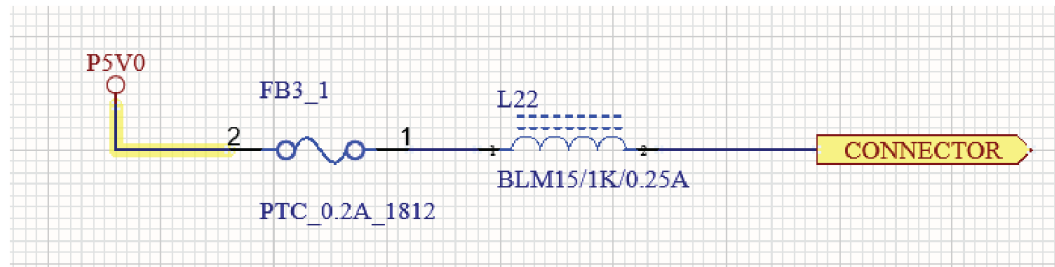

DB-44 PWR	Pin
GND	31

Dimensions

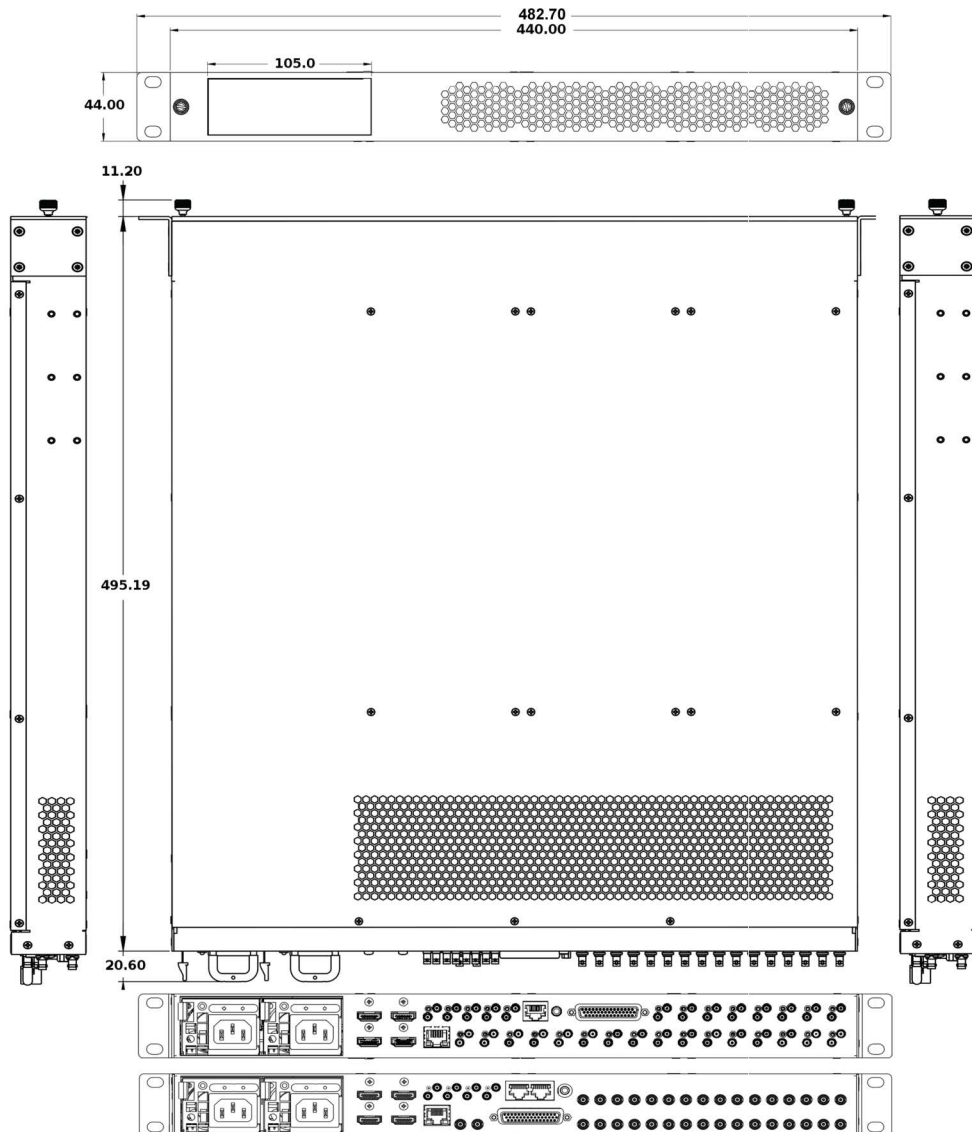



Grass Valley Technical Support

For technical assistance, contact our international support center, at 1-800-547-8949 (US and Canada) or +1 530 478 4148.

To obtain a local phone number for the support center nearest you, please consult the Contact Us section of Grass Valley's website (www.grassvalley.com).

An on-line form for e-mail contact is also available from the website.

Corporate Head Office

Grass Valley
3499 Douglas-B.-Floreani
St-Laurent, Quebec H4S 2C6
Canada
Telephone: +1 514 333 1772
Fax: +1 514 333 9828
www.grassvalley.com